

# SERVICE MANUAL



## BENEFON iO TGP-65-EU

## TGP-65-EU

<b>1.0 PRODUCT FEATURE DESCRIPTION</b> .....	<b>1 - 1</b>
1.1 Network standard .....	1 - 1
1.2 Physical dimensions .....	1 - 1
1.3 Display .....	1 - 1
1.4 Abbreviated dialling memory .....	1 - 1
1.5 Recent Calls memory .....	1 - 1
1.6 Clock functions .....	1 - 2
1.7 Additional network dependant features .....	1 - 2
1.8 SIM card .....	1 - 2
1.9 Power consumption .....	1 - 2
1.10 Other functions .....	1 - 2
1.11 Accessories .....	1 - 3
1.12 Manufacturer .....	1 - 3
1.13 PRODUCT FAMILY .....	1 - 4
<b>2.0 OWNER'S MANUAL</b> .....	<b>2 - 1</b>
<b>3.0 CAR KIT</b> .....	<b>3 - 1</b>
3.0.1 Light Holder KDC-65 .....	3 - 1
3.0.2 Microphone .....	3 - 1
3.0.3 Cable .....	3 - 1
3.0.4 External Handset HDS-50 .....	3 - 1
3.0.5 Car Box UDH-60 .....	3 - 2
3.0.6 Hf Speaker .....	3 - 2
<b>4.0 LOCAL SERVICE MODE</b> .....	<b>4 - 1</b>
4.1 SERVICE EQUIPMENT .....	4 - 1
4.1.1 General .....	4 - 1
4.1.2 Required equipment .....	4 - 1
4.1.3 Power source .....	4 - 2
4.2 GSERV .....	4 - 3
4.2.1 General .....	4 - 3
4.2.2 Installation .....	4 - 3
4.2.3 Starting GSERV .....	4 - 3
4.2.4 Troubleshooting .....	4 - 3

---

4.2.5 Remote control of measurement equipment .....	4 - 4
4.3 SERVICE MODE COMMANDS .....	4 - 5
4.3.1 Local mode .....	4 - 5
4.3.2 GSM mode .....	4 - 5
4.3.3 Service .....	4 - 5
4.3.4 Tuning .....	4 - 5
4.3.5 Memory and settings .....	4 - 6
4.3.6 Keyboard .....	4 - 6
4.3.7 About .....	4 - 6
4.4 TUNING INSTRUCTIONS .....	4 - 7
4.4.1 General .....	4 - 7
4.4.2 Base frequency .....	4 - 7
4.4.3 TX power .....	4 - 7
4.4.4 RX RSSI .....	4 - 8
4.4.5 A/D converter calibration .....	4 - 8
4.4.6 Contrast .....	4 - 9
4.4.7 Enable/Disable tuning values .....	4 - 9
<b>5.0 TECHNICAL DESCRIPTION .....</b>	<b>5 - 1</b>
5.0.1 Block diagram of the product .....	5 - 1
5.0.2 A technical explanation .....	5 - 1
5.1 Charging .....	5 - 2
5.2 HW and SW version numbering .....	5 - 2
5.2.1 Hardware version .....	5 - 2
5.2.2 Software version .....	5 - 2
5.3 Logic/audio module .....	3
5.3.1 Audio Controls .....	4
5.3.2 Connectors .....	5
5.3.3 Parts list OA1810 .....	8
5.4 RF-module .....	5 - 21
5.4.1 General .....	5 - 21
5.4.2 Receiver .....	5 - 22
5.4.3 Transmitter .....	5 - 22
5.4.4 Synthesizer .....	5 - 22
5.4.5 Power supply and power switching. ....	5 - 22
5.4.6 Antenna and antenna connector .....	5 - 23

5.4.7 Parts list OY1810 .....	5 - 24
5.5 MECHANICS .....	5 - 36

## 1.0 PRODUCT FEATURE DESCRIPTION

### 1.1 Network standard

GSM 900 phase 1 class 4 handportable (2W) with supporting Full Rate speech coding.

Additionally Benefon iO supports some phase 2 features.

No data services are supported.

### 1.2 Physical dimensions

Maximum dimensions without antenna are 56 x 123 x 23. Volume of the phone 158 cc.

Weight of the phone is around 155 g.

### 1.3 Display

Clear and easy to read full graphical 30x36 mm LCD. The display has 8 symbols consisting of 23 indicators. Text area has altogether 33x95 pixels. Minimum of 4x16 characters can be displayed simultaneously.

### 1.4 Abbreviated dialling memory

- extremely simple key strokes to call to abbreviated dialling numbers
- abbreviated dialling entries up to 255 depending of SIM card. For more information check your operator for details.
- for each number an alphanumeric string of 20 characters can be attached. This string is displayed if CLIP service notices an incoming call from saved number.
- memory scroll and recall in an alphabetical order

### 1.5 Recent Calls memory

- last dialled number memory for 15 entries, extremely simple key sequence to call these numbers
- last answered call identity memory for 5 entries
- last unanswered call identity memory for 5 entries
- memory scroll and recall in an alphabetical order
- BeneWin® Editor PC software for maintaining the abbreviated dialling number memory

## 1.6 Clock functions

- date and time display
- programmable alarm function
- programmable phone start up time and power down time (max. 24h)
- recent calls time stamping, see user manual for details

## 1.7 Additional network dependant features

- calling line identity presentation, CLIP
- multiparty calls between up to 5 users
- Short Message Service (SMS) capability for both receiving and sending messages

## 1.8 SIM card

Benefon iO uses plug in SIM card.

## 1.9 Power consumption

Battery cells: 4x 1.2 V NiMH. Three different battery packs are initially available; small with 750 mAh capacity, standard with 850 mAh capacity and power with 1600 mAh capacity.

Talk time is approximately 3.5 hours with full 2W transmit power. Maximum idle time is approximately 65 hours with 850 mAh battery, but it's heavily subject to GSM network configuration.

With 1600 mAh battery talk time is approximately 6.4 hours and maximum idle time is 120 hours.

## 1.10 Other functions

Benefon iO offers ten different ringing tones, also some other melody options.

## 1.11 Accessories

- mains charger
- cigarette lighter socket charger
- desktop charger for the phone and one reserve battery pack
- portable hands free kit
- BeneWin
- belt clip
- light holder

## 1.12 Manufacturer

BENEFON OYJ  
P.O. Box 84  
(Meriniitynkatu 11)  
FIN 24101 SALO  
FINLAND

Telephone: + 358 2 77 400

Telefax: + 358 2 332 633

## 1.13 PRODUCT FAMILY

- BENEFON iO HANDPORTABLE TGP-65-EU
- MAINS CHARGER CMA-60-230
- CIGARETTE LIGHTER CHARGER CCS 60-12
- DESKTOP CHARGER CTA-60
- LIGHT HOLDER
- PORTABLE HANDS FREE EHD-60
- BENEWIN SCA-60
- BELT CLIP



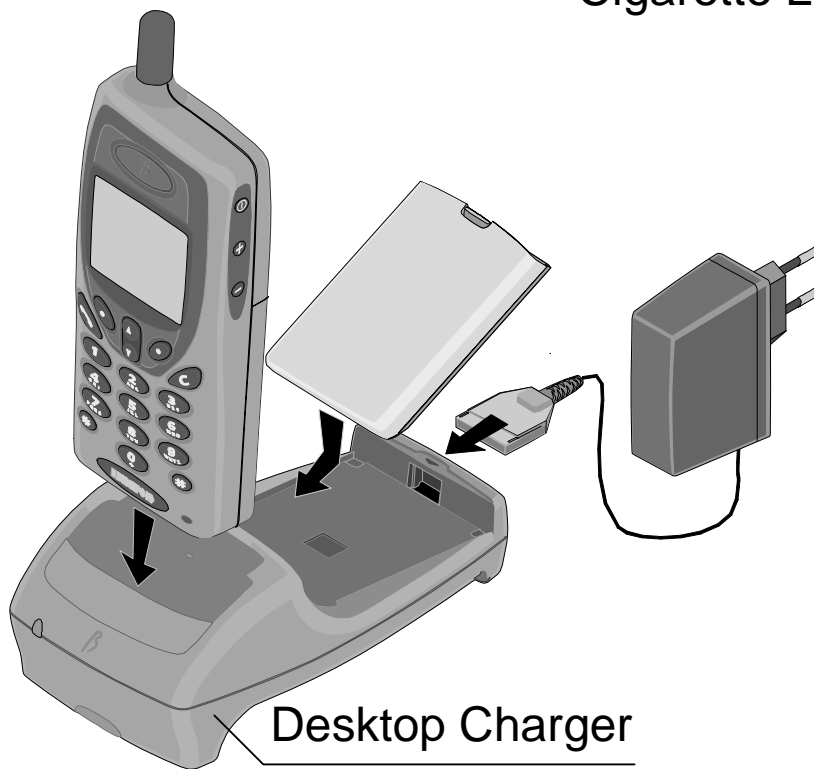
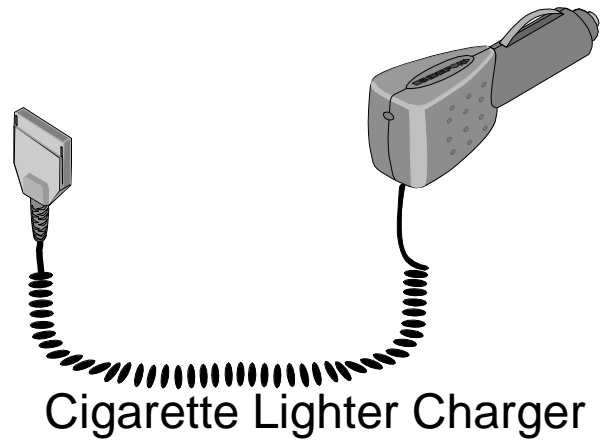
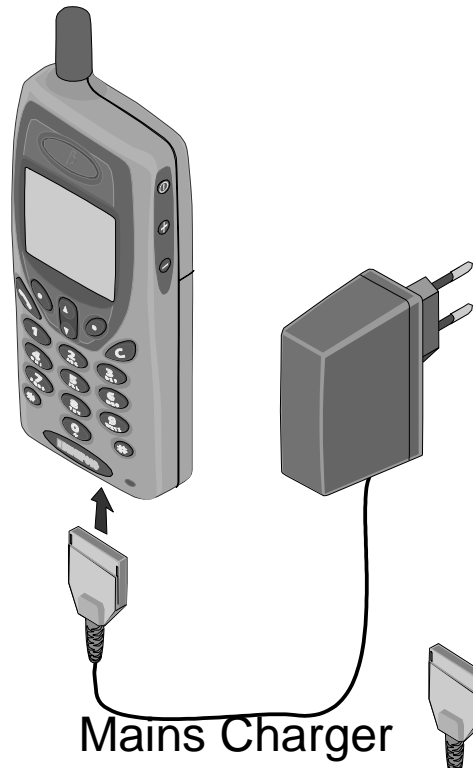

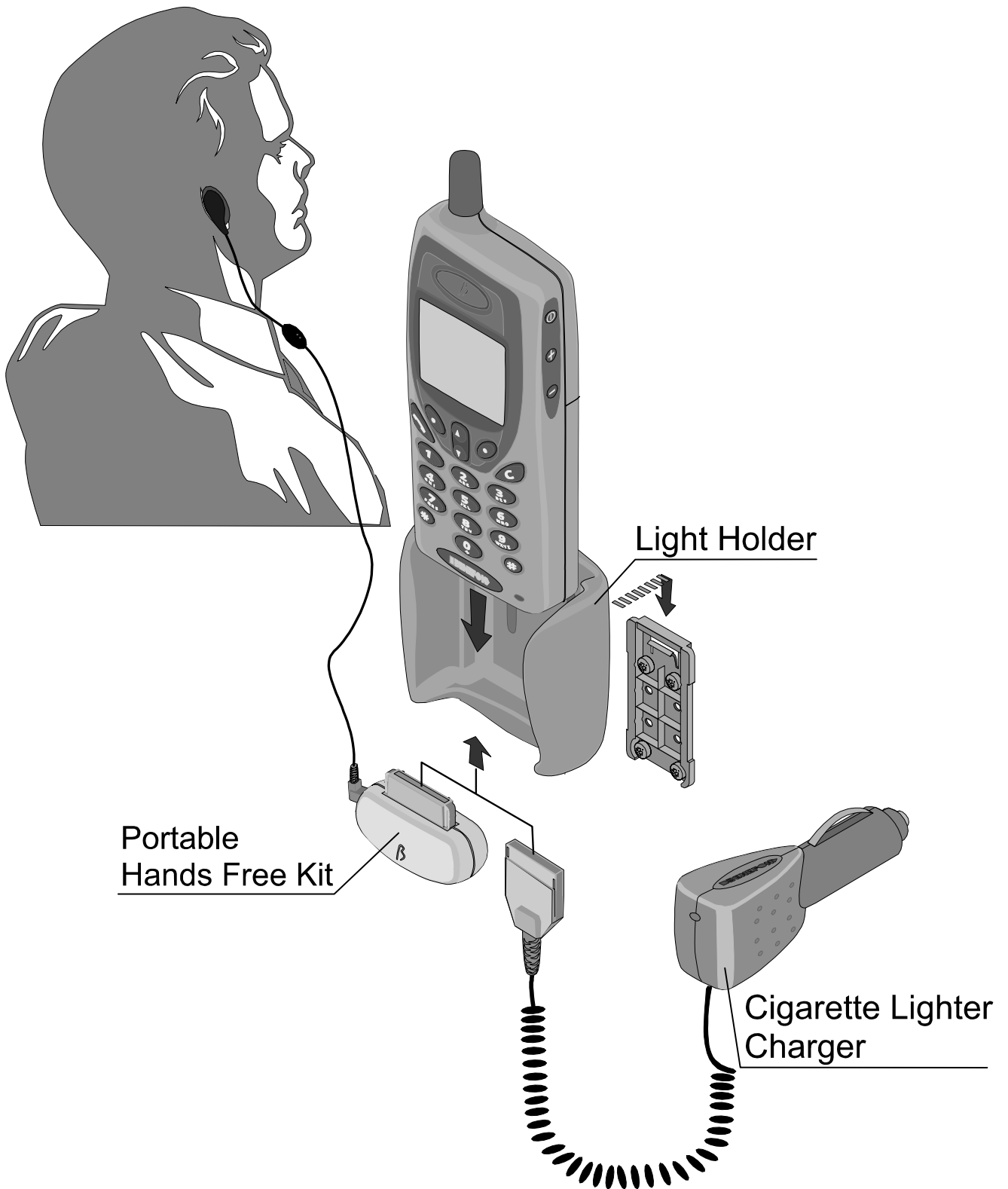

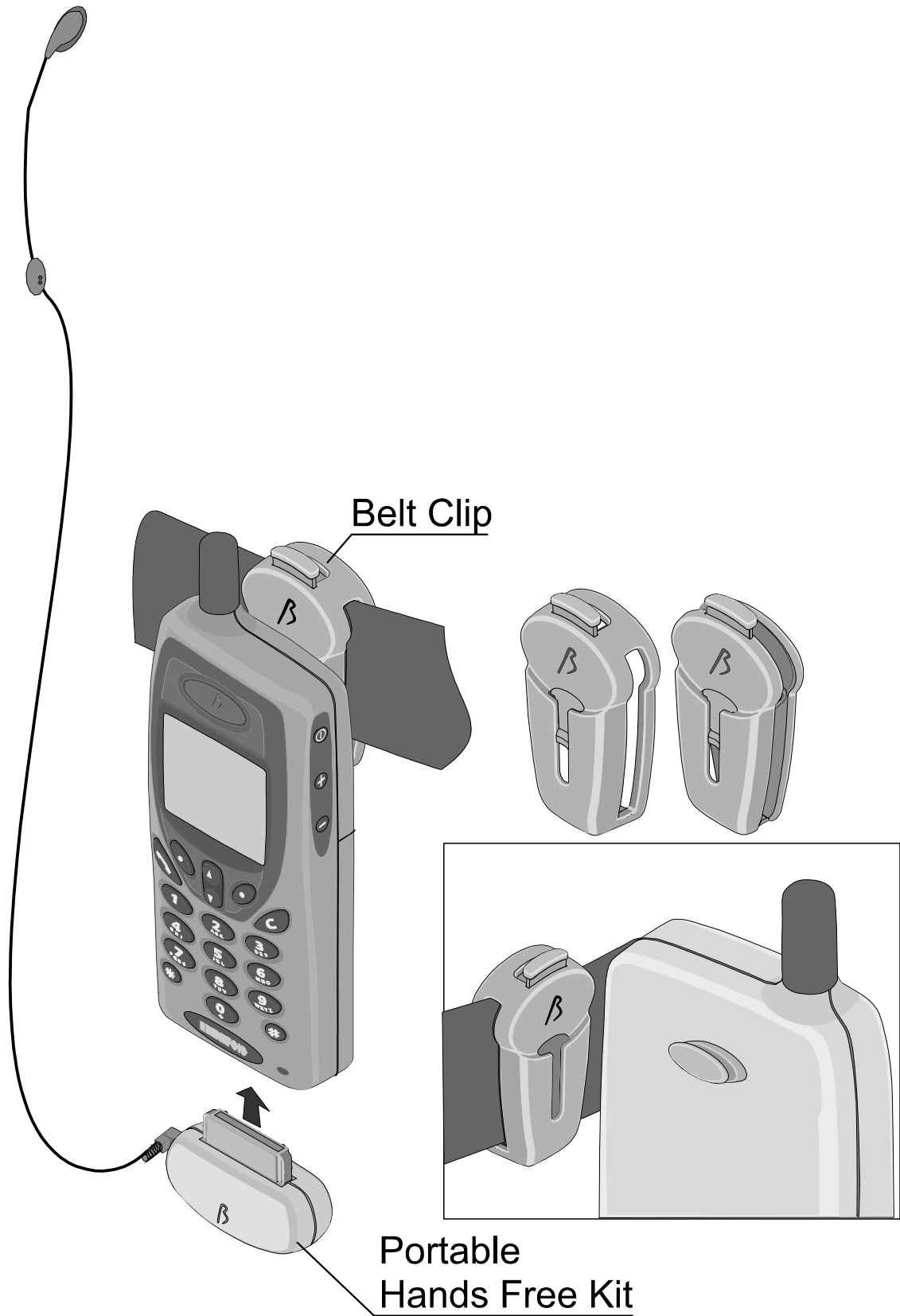

## BeneWin

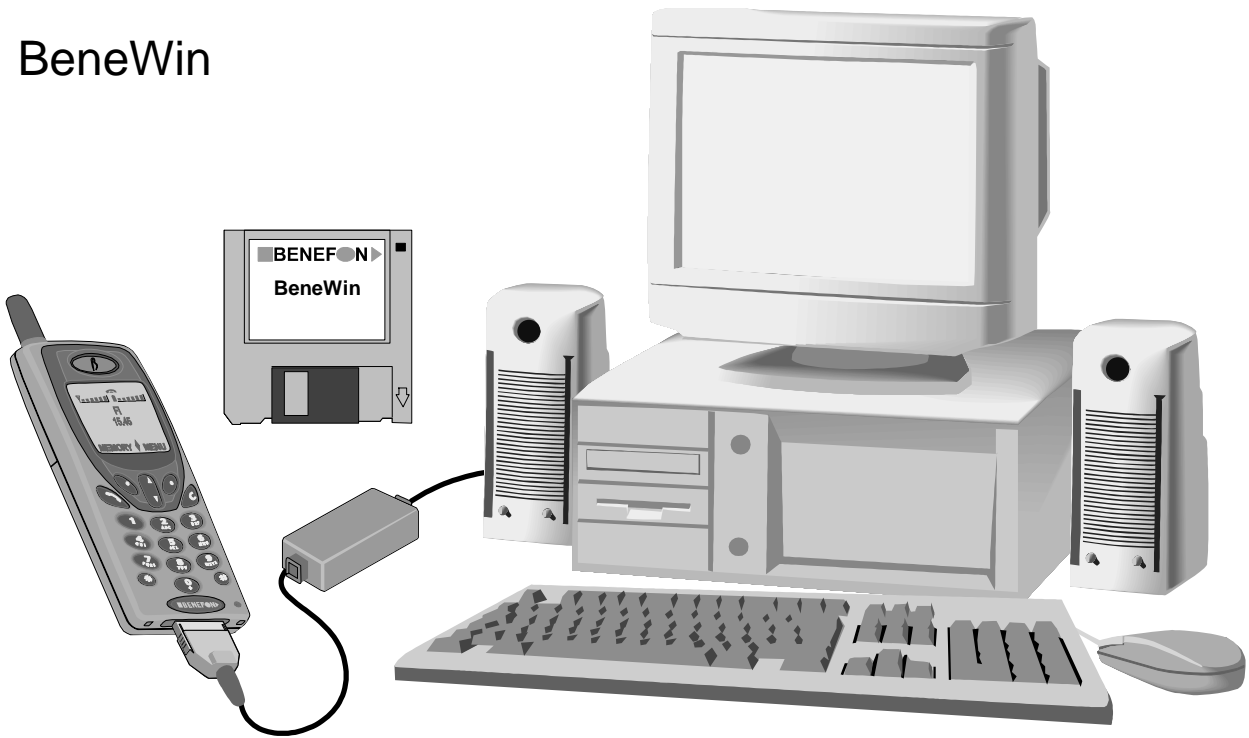

## 2.0 OWNER'S MANUAL

## 3.0 CAR KIT

The Car Kit includes a light holder (KDC-65), a car box (UDH-60), an installation base, a hf speaker, a microphone and a cable. The Car Kit sales package also includes an installation material bag, which contains the necessary installation equipment. On the next page you will find a diagram of connections explaining how to install the Car Kit.

Caution:

The Car Kit should be installed by Benefon authorized installer only. An end user should never attempt to install the Car Kit alone without any professional assistance. The professional installers have the required tools and knowledge to install the Car Kit properly and safely. Also the terms of warranty demand that the Car Kit is installed by professional personnel. Cable routing may cause interference with the components of the vehicle's electronic systems (such as ignition and braking systems). It is recommended that cable is not routed next to these electronic components.

### 3.0.1 Light Holder KDC-65

Choose such a place for the light holder in the vehicle that will be both easy and safe when using the phone. First, fix the installation base to the place you have chosen, and then install the light holder in the installation base.

### 3.0.2 Microphone

Install the microphone so that it is aimed directly at the user, and comes as close as possible to the user's mouth. A good place for the microphone is near the rearview mirror where the noise level is lower than, for example, beside a windshield pillar. It is also possible to install the microphone on a sun visor, but then it will be inconvenient to use the sun visor and microphone at the same time. One alternative would be a swan-neck microphone as it can be placed closest to the user's mouth.

### 3.0.3 Cable

Obtain the necessary +-electricity from a suitable place, preferably directly from the battery of the vehicle. Connect the fuse chamber to the +-wire. You will find the fuse chamber in the installation material bag. Connect the ground lead to the frame of the car with a short wire.

### 3.0.4 External Handset HDS-50

Install the external handset the same way as you installed the light holder.

### **3.0.5 Car Box UDH-60**

Place the car box out of sight inside the dashboard of the car or to another suitable place. First, connect the wires to the car box. Install the car box so that the heat sink has some space for cooling. The car box has holes which enable you to fasten the car box with a cable tie.

### **3.0.6 Hf Speaker**

Install the speaker in a suitable place near the floor of the car. To avoid echo remember to pay attention to the position of the microphone as well.

## A Diagram of Connections

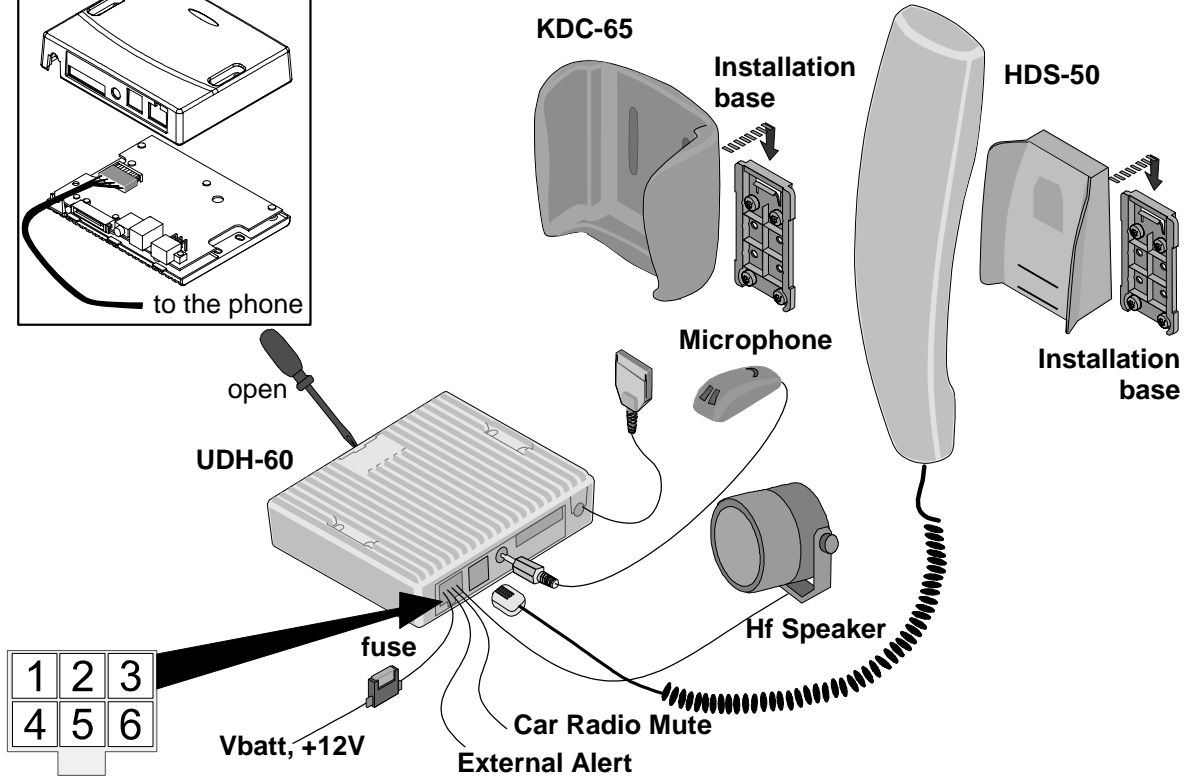
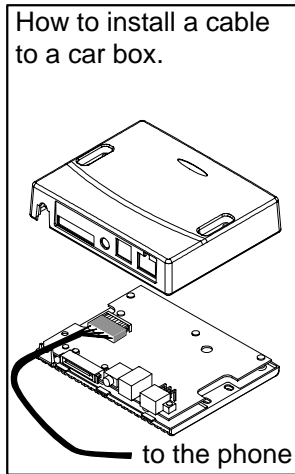

PIN	Name	Colour
1	Car Radio Mute (active low)	Blue
2	Hf Speaker	Grey
3	Ground	Black
4	External Alert (active low)	Brown
5	Hf Speaker	Grey
6	Vbatt, +12 V	Red

### Car Radio Mute (See the installation instructions of your car radio)

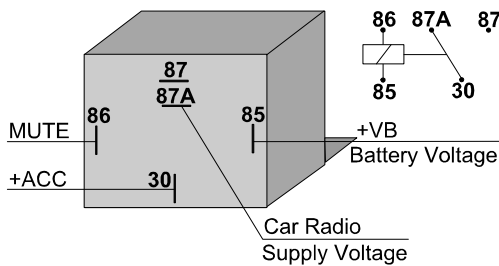

**+ACC:** to the +12 V power terminal which is energized in the accessory position of the ignition key

### External Alert

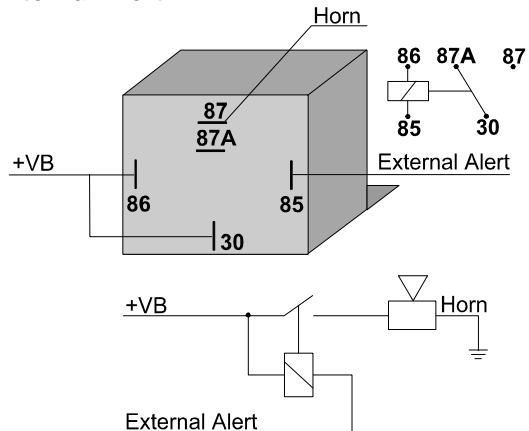



## 4.0 LOCAL SERVICE MODE

Local Service Mode

### 4.1 SERVICE EQUIPMENT

#### 4.1.1 General

The Benefon iO has a special service operation mode for testing and tuning. In this mode, all commands are sent via the serial communications bus to the phone. The keypad of the phone cannot be used.

A PC application has been created to help in using the service mode. The application can send command sequences needed in tuning procedures and store tuning parameters on the EEPROM chip in the phone afterwards.

A service adapter is needed to connect the phone and PC.

#### 4.1.2 Required equipment

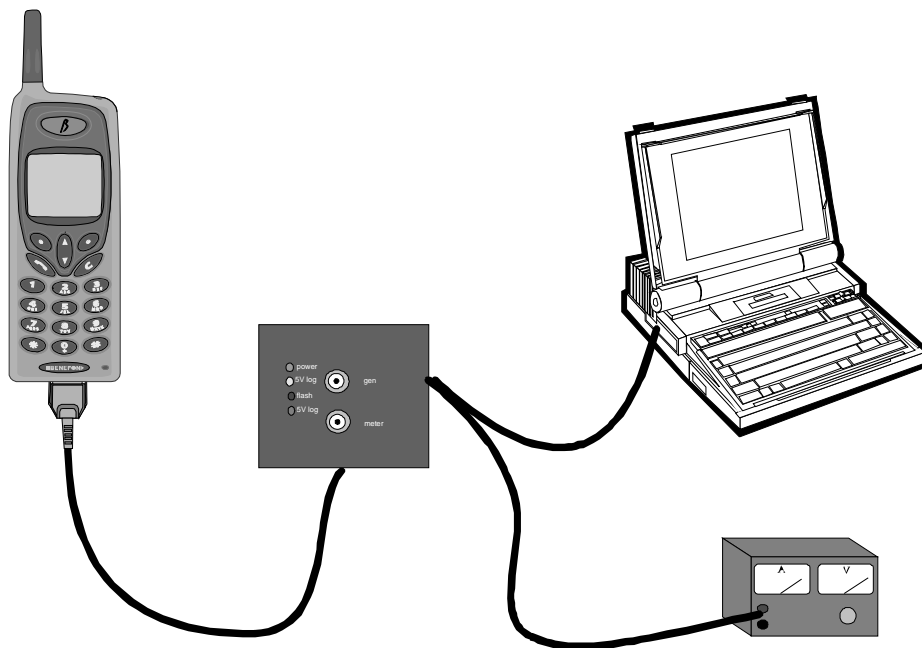

- IBM PC-compatible computer with 1.44" floppy disk drive and one free RS-232 serial communications port (COM1-COM4)
- GSERV software installation disk
- Benefon service adapter (Local box) QPS-50 or compatible
- Spica/Vega service cable (SPICA label on D-15 connector)
- Power supply with overcurrent protection

### 4.1.3 Power source

The service adapter has an external power supply input. This is connected to the V-CHG pin on phone's base connector. There is no current regulation or charge control circuitry between external power supply and phone battery (except a fuse inside the service adapter). Use the power supply with a 1 A current limit to protect the fuse and battery. You can still overcharge your battery if you leave the phone with battery connected to service adapter for a long period.

The service adapter takes its own operating power from the V-BAT pin on the base connector. You can use the service adapter without an external power supply if desired. However, you cannot perform A/D converter battery measurement reference value.tuning (you must be able to set the battery voltage very precisely).

The transmitter on a GSM phone takes very short, high-current pulses. You must have a battery pack or large capacitor (for example, 4700 microfarads/10 V) connected to battery pins if you are going to perform RF tuning and/or measurement. You can do logic board tests and update software without the battery or capacitor.

## 4.2 GSERV

### 4.2.1 General

GSERV is a PC utility program for controlling Benefon GSM phones in the service mode.

GSERV allows the user to check the functionality of mobile hardware blocks and also features tuning procedures if re-tuning of the mobile is necessary, such as after replacement of a component on the RF module.

### 4.2.2 Installation

GSERV can be run from a floppy disk, but it is recommended to create a new directory on your hard disk and copy all the files there. Please study the file README.TXT on your installation floppy disk for more specific installation instructions and information on the latest changes and updates regarding software and tuning procedures.

### 4.2.3 Starting GSERV

If your computer COM ports have a normal configuration (they probably do), you can start GSERV just by typing:

**gserv**                    if you use COM 1  
**gserv 2**                if you use COM 2

In any other case, the syntax will be:

**gserv <port> <irq>**, where:

<port> (1...4)        id number of port where the service adapter is connected  
                          default = 1  
<irq> (0...15)        interrupt request line number the port uses  
                          defaults for COM 1 and 3 = 4, COM 2 and 4 = 3

Your computer can stop responding or crash if you specify the wrong IRQ number. If you don't know what it is, don't attempt it.

### 4.2.4 Troubleshooting

Perform the tests below in the specified order. If one of these steps fails, fix the problem before you continue.

1. Connect phone to the service adapter and start GSERV. **The green power indicator light in the service adapter should be on.**

FAIL: Your service adapter doesn't have power. Check the service cable connection and power supply or phone battery, depending on which one you are using.

2. Move the cursor to item Local mode using arrow up/down keys and select by pressing Enter. **The red flash indicator in service adapter should go on for 0.5 seconds and then off every time you send a "Local mode" command.**

FAIL: You have started GSERV with the wrong COM port number. Try to use another number or move the service adapter cable to another COM connector in your PC.

3. **Phone should reset itself (display goes off and on) when you send "Local mode" command.**

FAIL: You have a problem in the service cable or in the phone. Try first to get the phone to work with the service adapter disconnected.

4. **Phone should go to Local mode when you restart it with a "Local mode" command** (SW version and phone type stays on phone display, keypad doesn't work).

FAIL: Your service adapter doesn't have the proper rights. Contact our After Sales department.

5. **Phone should go to GSM mode when you restart it with a "GSM mode" command** (Normal display on phone, keypad works).

FAIL: TX data connection (in PC - phone direction) is broken.

6. **You should be able to see messages from phone in the INFO window** (phone type, ID number, SW and HW version no. and operation mode information).

FAIL: Wrong IRQ value or RX data connection (in phone - PC direction) is broken.

7. **Your system is working - congratulations!**

## 4.2.5 Remote control of measurement equipment

A special version of GSERV features an automated testing routine which checks the unit before and after servicing. The test results are stored on a file with a name derived from the serial number of the MS.

This is identical to an "autotest" or "autorun" program which is implemented in most GSM test sets. However, GSERV can control both the phone and tester.

Our resources are limited, and we can only support some of the large number of GSM tester brands and models. So, if you think you could use this feature, contact the Benefon After Sales department to check if your tester is supported.

Other requirements:

- Your GSM tester must have a serial or GPIB remote control capability.
- For devices with GPIB connection, you need a GPIB controller board on your PC and a GPIB cable.
- For devices with a serial connection, you need a serial connection cable and (in addition to a phone control port) a free serial port .

## 4.3 SERVICE MODE COMMANDS

### 4.3.1 Local mode

Phone is restarted in Local mode.

### 4.3.2 GSM mode

Phone is restarted in normal operation mode.

### 4.3.3 Service

You can test the functionality of mobile blocks one by one.

On the RF board you can:

- switch TX and RX on and off
- change channel
- change transmitter power level
- change TXCO frequency
- monitor AGC level on receiver

On the logic board you can:

- read voltage and temperature A/D inputs
- test charger D/A output
- test display, lights and buzzer

### 4.3.4 Tuning

Tuning functions enable the user to perform adjustments and store settings in EEPROM.

These settings include:

- TCXO initial frequency
- TX power and template
- RX RSSI (RX Level reporting)
- battery voltage and temperature measurement
- LCD contrast

### **4.3.5 Memory and settings**

These functions include some options to control the contents of EEPROM:

- activate/deactivate EEPROM tuning values
- overwrite all user settings
- overwrite phone code.

### **4.3.6 Keyboard**

You can send keystrokes to the phone and monitor its display on the computer screen.

### **4.3.7 About**

Version number and other information about service software

## 4.4 TUNING INSTRUCTIONS

### 4.4.1 General

This is only a short overview of the tuning procedures. Please follow the more specific instructions in your service software.

### 4.4.2 Base frequency

This is the initial TCXO frequency correction value. A GSM mobile must adjust the base frequency according to the frequency synchronisation burst of the base station whenever it can hear one. Thus, this value is used only when the phone is searching for the first base station.

Exact tuning of this value may look useless when compared to the modulation bandwidth of GSM. However, a decent initial value may help synchronisation with the network on some conditions and it is a good idea to check that the TCXO control circuit is working.

#### 4.4.2.1 Tuning

Connect the GSM tester or frequency counter to the phone and select item "Tuning-Base frequency" from the menu. Adjust the frequency up or down until it is 902.0000 MHz +/- 100 Hz and save the value.

### 4.4.3 TX power

The transmitter power ramp has three specifications: power must be within the specified limits, the power curve must fit the power template, and spectrum due switching must be below the given maximum values.

The transmitter power ramp is controlled by an array of 32 register values. At the start of one transmitter burst, the first 15 values are assumed by the power control register to increase the power smoothly. The 16th value is used during actual data transmission. Values 17-32 are used after data transmission to decrease the power.

Because each value affects the power template and spectrum, adjusting the values individually is a very difficult and time-consuming job. Therefore, the ramp values are controlled with five parameters in the tuning software:

- Continuous power level
- Corner position of rising and falling edge
- Slope (speed) for rising and falling edge

For maximum battery life the highest power (PL 5) should be at a range 32.0 - 32.5 dBm on middle channel. Difference between power levels should be 1.8 - 2.0 dB.

#### 4.4.3.1 Tuning

Connect the GSM tester to the phone and select item "Tuning-TX power" from the menu. First adjust the minimum power level to the specified value and then the maximum power level.

Now two pairs of power control/output power values are known. From this information, the tuning software is able to create an approximation for the power control/output power curve of this particular unit and solve the power control value for each of the remaining nine power levels.

You can adjust the template to match by moving the corner positions and minimum spectrum by adjusting the rise/fall speed. Usually, the default values for the corner positions and speed should be correct. However, you should check the spectrum due switching on the two highest power levels and the power template on the two smallest power levels, especially the rising edge position. If any of these fail, you should check all levels.

#### 4.4.4 RX RSSI

A GSM mobile must be able to report the correct receiver input signal level (RXL) and quality (RXQ) to the base station. The reported RX level is calculated from the RF gain control value in the AGC circuit and I/Q demodulator input level, and corrected with calibration values individual to each phone.

##### 4.4.4.1 Tuning

Connect the GSM tester or RF signal generator to the phone and select item "Tuning-RX RSSI" from the menu. Adjust the generator according to the software directions.

The RX level measurement is performed and the difference between measured and actual value is calculated.

Measurement is repeated using different signal levels. After all measurements are completed, the calibration table is calculated and stored on EEPROM.

#### 4.4.5 A/D converter calibration

Remove the battery and connect a multimeter to the battery connector pins behind the phone. Adjust the external power supply voltage until the voltage of the battery pins is 5.0 +/- 0.01 volts.

The phone should be at room temperature (25 +/-5 degrees Celsius) for correct temperature calibration.

Select item "Tuning-A/D converter" from the menu. The input values of the battery voltage and temperature measurement channels are read and stored on EEPROM.



#### **4.4.6 Contrast**

Select item "Tuning-Contrast" from the menu. Adjust contrast to the preferred value and store.

#### **4.4.7 Enable/Disable tuning values**

A flag on EEPROM indicates if the tuning has been performed properly. If the tuning values are not activated, phone uses default values. The purpose is to prevent breakdown of the transmitter module and/or RF disturbance if the EEPROM is broken or accidentally erased.

When all the RF tuning is completed, remember to check the status of this flag and set it active if needed.

## 5.0 TECHNICAL DESCRIPTION

### 5.0.1 Block diagram of the product

See the Baseband block and a block diagram of radio module.

### 5.0.2 A technical explanation

Benefon iO phone has two main Printed Circuit Boards, PCS's. The one is for radio frequency functions above 300 kHz and the other is for the baseband functions below the 300 kHz limit. The interface between modules carries standard IQ signal on both transmit and receive paths.

Keypad and display are integrated onto the baseband.

Antenna is fixed  $\lambda/4$  length or helix.

## 5.1 Charging

Charger gives constant current controlled by CHGCONT pin on the base connector. Current can be controlled within the range of <100 mA to 1 A. Maximum voltage is below 8 volts.

When charger is connected, the CPU measures the battery voltage and selects a suitable charging current. Battery type, cell temperature and nominal capacity are read from the battery pack memory. Battery voltage is measured with PMB2905.

If mobile is powered off when charger is connected, the baseband circuitry operates the regulators exactly same way as with normal power on. However CPU notices that power on key was not pressed and starts necessary software to start charging.

## 5.2 HW and SW version numbering

### 5.2.1 Hardware version

HW version number consists of 8 digits, for example 62626340. HW version numbers are issued in alphabetical order (numbers preceding letters). ie. later HW versions come later in alphabetical order. HW version can be read with the same key sequence as SW version.

### 5.2.2 Software version

Software version code has format X.XXXXX, for example 0.290162.

SW version numbers are issued in alphabetical order (numbers preceding letters). ie. later SW versions come later in alphabetical order. From idle mode SW version can be read with key sequence `*#465336393#`. It's easier to remember as `*#GOLD-ENEYE#`. Key sequence also reveals the date of the SW package.

## 5.3 Logic/audio module

OA1810

Main functions of the GSM phone are composed with Siemens HiGold chipset. It operates on 3 V power source.

Baseband board is hereafter often referred as OA board.

**RX:** The amplified differential baseband signal is fed to the receive path input of Gaim. Both components I and Q are converted independently from each other from analog to digital forming two 13 Mbit/s bit streams. After signal reconstruction and digital filtering, equalization, channel and speech decoding and voiceband (interpolation) filtering on Gold-SP a resulting 1Mbit/s bit stream is digital-to-analog converted and amplified by a programmable gain stage in the voiceband processing part of GAIM. The output signal is directly connected to the earpiece.

**TX:** GAIM amplifies the input signal from the microphone. After analog-to-digital conversion a 1 Mbit/s bit stream is generated and forwarded to Gold-SP where voiceband (decimation) filtering, speech and channel encoding and GMSK modulation is performed. The digital 10 bit I and Q baseband components (GMSK modulated and 8 times oversampled) are delivered to GAIM in double-multiplexed form. They are converted in parallel from digital to analog and fed into RF.

## 5.3.1 Audio Controls

### 5.3.1.1 Main circuits and chips

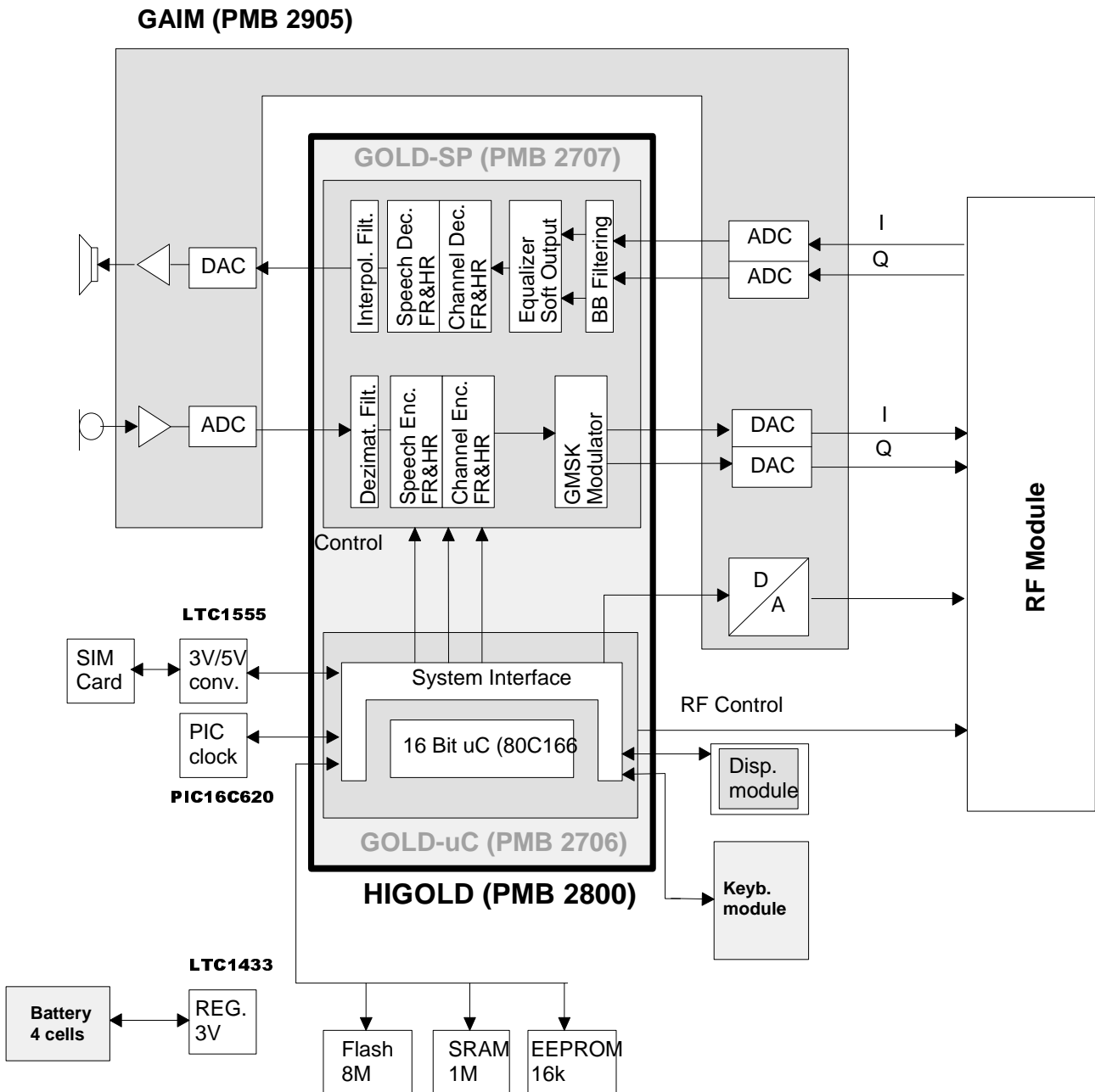

GAIM (PMB 2905) is a A/D converter chip that converts IQ signal into digital format and also creates analog transmitter signal for radio module. GAIM also converts the signals from mic and signal to erp.

Battery and temperature measurements but also the PA control is handled by GAIM.

HIGOLD (PMB 2800(SP PMB2707 and uC PMB2706)) is the main IC that could be handled as two different parts SP and uC. uC includes 80C166 CPU, channel coding functions, digital controls, GSM specific timers, DSP controls, SIM interface and MMI

controls. DSP includes two separate digital signal processors, fullrate speech coding, channel coding, data decryption and chiper key generation according to A52 algorithm.

CPU is 16 bit processor with a 2 megabyte memory address space. From this address space a RAM circuit uses 128\*8 kbits and flash PROM uses 1\*8 Mbits.

HIGOLD uses a 13 MHz external clock derived from radio module TCXO. The internal clock can be run on either 6.5, 13 or 26 MHz.

Keypad is a 4\*5 matrix and connected directly to HIGOLD IO pins. The display is a graphical 32\*95 pixel matrix including 23 symbols.

PIC processor (PIC16C620) takes care of Real Time Clock and has a protected memory where IMEI information is stored. PIC has its own 32 kHz oscillator and it runs independently and continuously (back up battery).

SIM card 3/5 V conversion IC. Since the logig runs on 3 V and the SIM card on 5 V the LTC1555 takes care of the conversion.

Baseband power supply is a LTC1433 step down DC/DC converter.

## 5.3.2 Connectors

### Base connector pin specification:

N	Name	Function	State	In/Out
1	V_Charge	Charge voltage for battery	Max 8V 1.3A	In
2	V_Charge	Charge voltage for battery	Max 8V 1.3A	In
3	V_BAT	Battery voltage	4.0-7.5V	Out
4	V_PROG	Flash programming voltage	12V	In
5	EXTMIC +PWR	External MIC signal Power on/off control	250 mVrms GND active	In
6	GND	Ground		
7	GND	Ground		
8	EXTERP +HOOK	External loudspeaker line +Hook identify	100mVrms +3V GND active	Out +In
9	AUXDET	Accessory identify for audio	0/3 V digital	In
10	I2CINT/ RXD0	Incoming RS323 data	0/3 V digital	In
11	TXD0/SCL	Outgoing RS323 data/I2C clock	0/3 V digital	Out
12	SDA/EXIO	General purpose IO/I2C data	0/3 V digital	In/Out
13	TXD1	Outgoing RS323 data	0/3 V digital	Out
14	RXD1	Incoming RS323 data	0/3 V digital	In
15	EXTIO	Headset identify IO	0/3 V digital	In
16	CHGCONT	Charger control	0..3V DC	Out

**RF / baseband module connector pins:**

Pin	Name	Explanation
1	IRX	RX I
2	IR	RX I
3	GND	
4	OCE	Offset compensation
5	SYGCCL	3 wire buss clock
6	SYGCDT	3 wire buss data
7	RFON	RF regulators on/off control
8	GND	
9	AFC	13MHz clock frequency tuning
10	GND	
11	QTX	TX Q
12	QT	TX Q
13	ITX	TX I
14	IT	TX I
15	TREF	Temperature reference voltage
16	PUPLO	Power up local buffer
17	GND	
18	RXON2	Power up RX
19	TXON1	Power up TX
20	CLOCK	13MHz TCXO clock from RF to BB
21	VCC	3V vcc from BB to RF
22-28	VBAT	Battery voltage to RF
29	PAOUT	Power control of transmitter
30	GND	
31	PDBUFRX	Power down RX buffer
32	SLEEP	Sleep TX
33	RXON1	RX on/off control
34	NC	Not connected
35	SYNSTR	Synthesizer strobe
36	GND	
37	PGCSTR	Programmable gain control strobe
38	GND	
39	QRX	RX Q
40	QR	RX Q

**Battery connector:**

Pin	Name	Explanation
1	VBAT	Battery Voltage
2	P3.5	Battery data
3	P2.4	V M control
4	GND	

**DAI interface connector (audio Type Approval test):**

Pin	Name
1	GND
2	NC
3	RFS
4	RXD
5	TFS
6	TXD
7	SCLK
8	UR1IN1

**Test connector (flash + PIC programming):**

Pin name	Explanation
TP201	CLK (PIC)
TP202	Data (PIC)
TP200	13V (PIC)
TP203	5V (PIC)
TP204	GND (PIC, flash)
TP208	V_PROG (flash)
TP209	V_BAT (flash)
TP206	RXD1 (flash)
TP207	TXD1 (flash)



### 5.3.3 Parts list OA1810

CODE	PART	DESCRIPT.	VALUE	MANUF.	TYPE
AE0023	A300	Dynamic transducer	13,3x2,6 low Z	Philips	WD00518/32U
AB0621	A500	Backup-akku 3,4V	Lithium-ion/Manganese Oxide	Varta	MC621
OO0522	A601	Matrix display module	Vcc 3.3V	Alps	??????
CG0223	C100	SMD capasitor X7R	22nF +80/-20%	Murata	
CG0223	C101	SMD capasitor X7R	22nF +80/-20%	Murata	
CG0680	C102	SMD capasitor NPO	68pF ñ5%	Murata	
CG0680	C103	SMD capasitor NPO	68pF ñ5%	Murata	
CG0680	C104	SMD capasitor NPO	68pF ñ5%	Murata	
CG0680	C105	SMD capasitor NPO	68pF ñ5%	Murata	
CG0680	C106	SMD capasitor NPO	68pF ñ5%	Murata	
CG0680	C107	SMD capasitor NPO	68pF ñ5%	Murata	
CG0680	C108	SMD capasitor NPO	68pF ñ5%	Murata	
CG0680	C109	SMD capasitor NPO	68pF ñ5%	Murata	
CG0680	C110	SMD capasitor NPO	68pF ñ5%	Murata	
CG0680	C111	SMD capasitor NPO	68pF ñ5%	Murata	
CG0680	C112	SMD capasitor NPO	68pF ñ5%	Murata	
CG0680	C113	SMD capasitor NPO	68pF ñ5%	Murata	
CG0680	C114	SMD capasitor NPO	68pF ñ5%	Murata	
CH0105	C115	SMD capasitor	1uF/-20/+80%/16V	TaiyoYuden	EMK212 F105Z00T
CG0680	C116	SMD capasitor NPO	68pF ñ5%	Murata	
CG0680	C117	SMD capasitor NPO	68pF ñ5%	Murata	
CG0680	C131	SMD capasitor NPO	68pF ñ5%	Murata	
CG0680	C138	SMD capasitor NPO	68pF ñ5%	Murata	
CG0680	C139	SMD capasitor NPO	68pF ñ5%	Murata	
CG0680	C140	SMD capasitor NPO	68pF ñ5%	Murata	
CG0680	C141	SMD capasitor NPO	68pF ñ5%	Murata	
CG0680	C143	SMD capasitor NPO	68pF ñ5%	Murata	
CD0104	C201	SMD capasitor	100 nF 10% 50 V X7R	Philips	
CU3106	C202	SMD tantal	10uF / 6V +20%	AVX	TAJA106M006R
CU3106	C203	SMD tantal	10uF / 6V +20%	AVX	TAJA106M006R
CG0103	C208	SMD capasitor X7R	10nF ñ10%	Murata	
CD0104	C209	SMD capasitor	100 nF 10% 50 V X7R	Philips	
CD0104	C210	SMD capasitor	100 nF 10% 50 V X7R	Philips	
CD0104	C211	SMD capasitor	100 nF 10% 50 V X7R	Philips	
CD0104	C212	SMD capasitor	100 nF 10% 50 V X7R	Philips	
CD0104	C213	SMD capasitor	100 nF 10% 50 V X7R	Philips	
CD0104	C214	SMD capasitor	100 nF 10% 50 V X7R	Philips	
CD0104	C215	SMD capasitor	100 nF 10% 50 V X7R	Philips	
CD0104	C216	SMD capasitor	100 nF 10% 50 V X7R	Philips	
CD0104	C218	SMD capasitor	100 nF 10% 50 V X7R	Philips	
CG0150	C221	SMD capasitor NPO	15pF ñ5%	Murata	
CG0150	C223	SMD capasitor NPO	15pF ñ5%	Murata	
CG0150	C225	SMD capasitor NPO	15pF ñ5%	Murata	
CG0150	C229	SMD capasitor NPO	15pF ñ5%	Murata	
CG0150	C231	SMD capasitor NPO	15pF ñ5%	Murata	
CG0150	C233	SMD capasitor NPO	15pF ñ5%	Murata	
CG0150	C235	SMD capasitor NPO	15pF ñ5%	Murata	
CG0150	C237	SMD capasitor NPO	15pF ñ5%	Murata	
CG0470	C239	SMD capasitor NPO	47pF ñ5%	Murata	
CG0150	C240	SMD capasitor NPO	15pF ñ5%	Murata	
CH0105	C241	SMD capasitor	1uF/-20/+80%/16V	TaiyoYuden	EMK212 F105Z00T
CG0223	C242	SMD capasitor X7R	22nF +80/-20%	Murata	
CG0103	C244	SMD capasitor X7R	10nF ñ10%	Murata	
CD0104	C310	SMD capasitor	100 nF 10% 50 V X7R	Philips	
CD0682	C311	SMD capasitor	6.8 nF 10% 50 V X7R	Philips	
CD0104	C312	SMD capasitor	100 nF 10% 50 V X7R	Philips	
CG0332	C313	SMD capasitor X7R	3.3nF ñ10%	Murata	

CODE	PART	DESCRIPT.	VALUE	MANUF.	TYPE
CH0105	C314	SMD capasitor	1uF/-20/+80%/16V	TaiyoYuden	EMK212 F105Z00T
CG0103	C315	SMD capasitor X7R	10nF ñ10%	Murata	
CG0103	C316	SMD capasitor X7R	10nF ñ10%	Murata	
CG0680	C317	SMD capasitor NPO	68pF ñ5%	Murata	
CG0680	C318	SMD capasitor NPO	68pF ñ5%	Murata	
CG0680	C320	SMD capasitor NPO	68pF ñ5%	Murata	
CD0104	C321	SMD capasitor	100 nF 10% 50 V X7R	Philips	
CD0104	C322	SMD capasitor	100 nF 10% 50 V X7R	Philips	
CD0104	C323	SMD capasitor	100 nF 10% 50 V X7R	Philips	
CD0104	C324	SMD capasitor	100 nF 10% 50 V X7R	Philips	
CD0104	C325	SMD capasitor	100 nF 10% 50 V X7R	Philips	
CG0102	C326	SMD capasitor X7R	1nF ñ10%	Murata	
CG0102	C328	SMD capasitor X7R	1nF ñ10%	Murata	
CG0102	C329	SMD capasitor X7R	1nF ñ10%	Murata	
CG0150	C332	SMD capasitor NPO	15pF ñ5%	Murata	
CG0150	C334	SMD capasitor NPO	15pF ñ5%	Murata	
CG0681	C336	SMD capasitor X7R	680pF ñ10%	Murata	
CG0680	C357	SMD capasitor NPO	68pF ñ5%	Murata	
CG0680	C358	SMD capasitor NPO	68pF ñ5%	Murata	
CG0223	C400	SMD capasitor X7R	22nF +80/-20%	Murata	
CG0103	C410	SMD capasitor X7R	10nF ñ10%	Murata	
CU3106	C500	SMD tantal	10uF / 6V +-20%	AVX	TAJA106M006R
CG0103	C501	SMD capasitor X7R	10nF ñ10%	Murata	
CG0103	C502	SMD capasitor X7R	10nF ñ10%	Murata	
CG0223	C503	SMD capasitor X7R	22nF +80/-20%	Murata	
CU3106	C504	SMD tantal	10uF / 6V +-20%	AVX	TAJA106M006R
CH0105	C507	SMD capasitor	1uF/-20/+80%/16V	TaiyoYuden	EMK212 F105Z00T
CD0104	C509	SMD capasitor	100 nF 10% 50 V X7R	Philips	
CU1107	C510	SMD tantal	100uF/10V +-20%	AVX	TAJD107M010R
CU1107	C511	SMD tantal	100uF/10V +-20%	AVX	TAJD107M010R
CD0104	C512	SMD capasitor	100 nF 10% 50 V X7R	Philips	
CD0104	C517	SMD capasitor	100 nF 10% 50 V X7R	Philips	
CG0330	C518	SMD capasitor NPO	33pF ñ5%	Murata	
CG0222	C519	SMD capasitor X7R	2.2nF ñ10%	Murata	
CG0332	C520	SMD capasitor X7R	3.3nF ñ10%	Murata	
CG0680	C521	SMD capasitor NPO	68pF ñ5%	Murata	
CU0335	C600	SMD tanlat	3.3uF/16V/20%	AVX/KYO-CER	TAJA335M016R
CU0335	C601	SMD tanlat	3.3uF/16V/20%	AVX/KYO-CER	TAJA335M016R
CU0335	C602	SMD tanlat	3.3uF/16V/20%	AVX/KYO-CER	TAJA335M016R
CD0334	C603	SMD capasitor	330nF 10% 16V X7R	AVX	
CD0334	C604	SMD capasitor	330nF 10% 16V X7R	AVX	
CD0334	C605	SMD capasitor	330nF 10% 16V X7R	AVX	
CD0334	C606	SMD capasitor	330nF 10% 16V X7R	AVX	
CD0334	C607	SMD capasitor	330nF 10% 16V X7R	AVX	
DY0014	D100	SMD diode	1,5A/40V	Shindengen	D1FS4A
DZ0339	D500	SMD zener	3V3 5% 300mW	Philips	BZX84-C3V3
DS1070	D501	SMD diode pair	70V/100mA common cathode	Philips	BAV 70W
DS1070	D503	SMD diode pair	70V/100mA common cathode	Philips	BAV 70W
DS1070	D504	SMD diode pair	70V/100mA common cathode	Philips	BAV 70W
DS1070	D505	SMD diode pair	70V/100mA common cathode	Philips	BAV 70W
DY0015	D506	SMD shottky diode	40V/1A VF=0.6V	Motorola	MBRS140T3
DS1070	D507	SMD diode pair	70V/100mA common cathode	Philips	BAV 70W
DLG190	D600	SMD led green	20mcd/20mA	Citizen	CL-190G
DLG190	D601	SMD led green	20mcd/20mA	Citizen	CL-190G
DLG190	D602	SMD led green	20mcd/20mA	Citizen	CL-190G
DLG190	D603	SMD led green	20mcd/20mA	Citizen	CL-190G
DLG190	D604	SMD led green	20mcd/20mA	Citizen	CL-190G

CODE	PART	DESCRIPT.	VALUE	MANUF.	TYPE
DLG190	D605	SMD led green	20mcd/20mA	Citizen	CL-190G
DLG190	D606	SMD led green	20mcd/20mA	Citizen	CL-190G
DLG190	D613	SMD led green	20mcd/20mA	Citizen	CL-190G
DLG190	D614	SMD led green	20mcd/20mA	Citizen	CL-190G
DLG190	D615	SMD led green	20mcd/20mA	Citizen	CL-190G
DLG190	D616	SMD led green	20mcd/20mA	Citizen	CL-190G
DLG190	D640	SMD led green	20mcd/20mA	Citizen	CL-190G
DLG190	D641	SMD led green	20mcd/20mA	Citizen	CL-190G
DLG190	D642	SMD led green	20mcd/20mA	Citizen	CL-190G
DLG190	D643	SMD led green	20mcd/20mA	Citizen	CL-190G
DLG190	D644	SMD led green	20mcd/20mA	Citizen	CL-190G
DLG190	D645	SMD led green	20mcd/20mA	Citizen	CL-190G
DLG190	D646	SMD led green	20mcd/20mA	Citizen	CL-190G
DLG190	D647	SMD led green	20mcd/20mA	Citizen	CL-190G
AF4300	F100	SMD fuse	3.15A/4.5x2.5x1.9mm		
AF1005	F101	SMD PTC Fuse	0.5A	Raychem	miniSMD050-2
IX2800	I200	Baseband processor	Kot. P-TQFP-144-1	Siemens	PMB2800
IP1655	I201	Microcontroller	EPROM-based 8bit	MicroChip	PIC16C554
IR1555	I202	SIM power supply and lev	el translator	LinearTech	LTC1555CGN
IX2905	I301	GSM analog interf.module	Kot. P-TQFP-64-1	Siemens	PMB2905
IM1600	I401	Flash memory	16Mb 90ms 3V uniform sector	AMD	AM29LV017B-90EC
IM2465	I403	EEPROM	8x8k / 3V	Atmel	AT24C64-10SI-2.7
IM0999	I404	SRAM 70ns/3V	1Mb 131,072x8	UMC	UM62S1024X-70LLT
IR1433	I500	DC/DC converter	3.5--13.5v/450mA	LinearTech	LTC1433GN
IR5205	I501	Voltage regulator	3.3V/1%/50mA	Micrel	LP2982IM5-3.3
LC0107	L500	SMD coil	100uH +-20% I=0.39mA	Sumida	CDRH62-101
QS0848	Q400	SMD transistor	NPN 0.1A/30V hFE 110-800	Philips	BC848BW, 115
QF0138	Q401	N-channel fet	50V/0,2A	Motorola	BSS138LT1
QF0138	Q500	N-channel fet	50V/0,2A	Motorola	BSS138LT1
QS0848	Q501	SMD transistor	NPN 0.1A/30V hFE 110-800	Philips	BC848BW, 115
QS0858	Q502	SMD transistor	PNP 0.1A/30V hFE 125-800	Philips	BC858BW
QF0138	Q602	N-channel fet	50V/0,2A	Motorola	BSS138LT1
QS0848	Q603	SMD transistor	NPN 0.1A/30V hFE 110-800	Philips	BC848BW, 115
RG0103	R101	SMD resistor	10k 5% 0.063W	Kamaya	RMC1/16S
RG0105	R102	SMD resistor	1M0 5% 0.063W	Kamaya	RMC1/16S
RG0104	R103	SMD resistor	100k 5% 0.063W	Kamaya	RMC1/16S
RG0104	R104	SMD resistor	100k 5% 0.063W	Kamaya	RMC1/16S
RG0104	R105	SMD resistor	100k 5% 0.063W	Kamaya	RMC1/16S
RG0105	R106	SMD resistor	1M0 5% 0.063W	Kamaya	RMC1/16S
RG0104	R107	SMD resistor	100k 5% 0.063W	Kamaya	RMC1/16S
RG0102	R108	SMD resistor	1k0 5% 0.063W	Kamaya	RMC1/16S
RG0101	R109	SMD resistor	100R 5% 0.063W	Kamaya	RMC1/16S
RG0101	R110	SMD resistor	100R 5% 0.063W	Kamaya	RMC1/16S
RG0101	R111	SMD resistor	100R 5% 0.063W	Kamaya	RMC1/16S
RG0101	R112	SMD resistor	100R 5% 0.063W	Kamaya	RMC1/16S
RG0101	R113	SMD resistor	100R 5% 0.063W	Kamaya	RMC1/16S
RG0101	R114	SMD resistor	100R 5% 0.063W	Kamaya	RMC1/16S
RG0101	R115	SMD resistor	100R 5% 0.063W	Kamaya	RMC1/16S
RG0101	R116	SMD resistor	100R 5% 0.063W	Kamaya	RMC1/16S
RG0103	R117	SMD resistor	10k 5% 0.063W	Kamaya	RMC1/16S
RD0102	R118	SMD resistor	1 k 5% 0.125 W	Kamaya	
RG0104	R119	SMD resistor	100k 5% 0.063W	Kamaya	RMC1/16S
RG0000	R120	SMD resistor	0 ohm		
RG0222	R121	SMD resistor	2k2 5% 0.063W	Kamaya	RMC1/16S
RG0332	R122	SMD resistor	3k3 5% 0.063W	Kamaya	RMC1/16S
RG0101	R123	SMD resistor	100R 5% 0.063W	Kamaya	RMC1/16S
RG0101	R124	SMD resistor	100R 5% 0.063W	Kamaya	RMC1/16S
RG0101	R125	SMD resistor	100R 5% 0.063W	Kamaya	RMC1/16S
RG0103	R202	SMD resistor	10k 5% 0.063W	Kamaya	RMC1/16S
RG0103	R203	SMD resistor	10k 5% 0.063W	Kamaya	RMC1/16S

CODE	PART	DESCRIPT.	VALUE	MANUF.	TYPE
RG0103	R204	SMD resistor	10k 5% 0.063W	Kamaya	RMC1/16S
RG0101	R209	SMD resistor	100R 5% 0.063W	Kamaya	RMC1/16S
RG0101	R210	SMD resistor	100R 5% 0.063W	Kamaya	RMC1/16S
RG0101	R211	SMD resistor	100R 5% 0.063W	Kamaya	RMC1/16S
RG0102	R213	SMD resistor	1k0 5% 0.063W	Kamaya	RMC1/16S
RG0101	R214	SMD resistor	100R 5% 0.063W	Kamaya	RMC1/16S
RG0101	R215	SMD resistor	100R 5% 0.063W	Kamaya	RMC1/16S
RG0101	R216	SMD resistor	100R 5% 0.063W	Kamaya	RMC1/16S
RG0101	R217	SMD resistor	100R 5% 0.063W	Kamaya	RMC1/16S
RG0101	R218	SMD resistor	100R 5% 0.063W	Kamaya	RMC1/16S
RG0101	R219	SMD resistor	100R 5% 0.063W	Kamaya	RMC1/16S
RG0103	R220	SMD resistor	10k 5% 0.063W	Kamaya	RMC1/16S
RG0103	R221	SMD resistor	10k 5% 0.063W	Kamaya	RMC1/16S
RG0105	R251	SMD resistor	1M0 5% 0.063W	Kamaya	RMC1/16S
RG0000	R305	SMD resistor	0 ohm		
RG0102	R306	SMD resistor	1k0 5% 0.063W	Kamaya	RMC1/16S
RG0152	R307	SMD resistor	1k5 5% 0.063W	Kamaya	RMC1/16S
RG1303	R309	SMD resistor	30K 1% 0.063W	KOA	
RG0103	R312	SMD resistor	10k 5% 0.063W	Kamaya	RMC1/16S
RG0103	R314	SMD resistor	10k 5% 0.063W	Kamaya	RMC1/16S
RG0101	R321	SMD resistor	100R 5% 0.063W	Kamaya	RMC1/16S
RG0101	R322	SMD resistor	100R 5% 0.063W	Kamaya	RMC1/16S
RG0102	R323	SMD resistor	1k0 5% 0.063W	Kamaya	RMC1/16S
RG0104	R330	SMD resistor	100k 5% 0.063W	Kamaya	RMC1/16S
RG0274	R331	SMD resistor	270k 5% 0.063W	Kamaya	RMC1/16S
RG0104	R332	SMD resistor	100k 5% 0.063W	Kamaya	RMC1/16S
RG0104	R333	SMD resistor	100k 5% 0.063W	Kamaya	RMC1/16S
RG0223	R340	SMD resistor	22k 5% 0.063W	Kamaya	RMC1/16S
RTN157	R341	(RNT157)NTC resistor	22k 5% B=3750	Ohizumi	157-223-65001
RG0000	R345	SMD resistor	0 ohm		
RG0103	R402	SMD resistor	10k 5% 0.063W	Kamaya	RMC1/16S
RG0103	R403	SMD resistor	10k 5% 0.063W	Kamaya	RMC1/16S
RG0103	R404	SMD resistor	10k 5% 0.063W	Kamaya	RMC1/16S
RG0104	R405	SMD resistor	100k 5% 0.063W	Kamaya	RMC1/16S
RG0103	R406	SMD resistor	10k 5% 0.063W	Kamaya	RMC1/16S
RG0274	R407	SMD resistor	270k 5% 0.063W	Kamaya	RMC1/16S
RG0102	R408	SMD resistor	1k0 5% 0.063W	Kamaya	RMC1/16S
RG0103	R410	SMD resistor	10k 5% 0.063W	Kamaya	RMC1/16S
RG0103	R500	SMD resistor	10k 5% 0.063W	Kamaya	RMC1/16S
RG0101	R501	SMD resistor	100R 5% 0.063W	Kamaya	RMC1/16S
RG0104	R502	SMD resistor	100k 5% 0.063W	Kamaya	RMC1/16S
RG0104	R503	SMD resistor	100k 5% 0.063W	Kamaya	RMC1/16S
RG0104	R504	SMD resistor	100k 5% 0.063W	Kamaya	RMC1/16S
RG0102	R505	SMD resistor	1k0 5% 0.063W	Kamaya	RMC1/16S
RG0223	R506	SMD resistor	22k 5% 0.063W	Kamaya	RMC1/16S
RG0105	R507	SMD resistor	1M0 5% 0.063W	Kamaya	RMC1/16S
RG0104	R509	SMD resistor	100k 5% 0.063W	Kamaya	RMC1/16S
RG0104	R510	SMD resistor	100k 5% 0.063W	Kamaya	RMC1/16S
RG0104	R511	SMD resistor	100k 5% 0.063W	Kamaya	RMC1/16S
RG0103	R512	SMD resistor	10k 5% 0.063W	Kamaya	RMC1/16S
RG0472	R513	SMD resistor	4k7 5% 0.063W	Kamaya	RMC1/16S
RG0223	R514	SMD resistor	22k 5% 0.063W	Kamaya	RMC1/16S
RG0103	R515	SMD resistor	10k 5% 0.063W	Kamaya	RMC1/16S
RG0223	R516	SMD resistor	22k 5% 0.063W	Kamaya	RMC1/16S
RG0104	R517	SMD resistor	100k 5% 0.063W	Kamaya	RMC1/16S
RG0103	R518	SMD resistor	10k 5% 0.063W	Kamaya	RMC1/16S
RG0104	R521	SMD resistor	100k 5% 0.063W	Kamaya	RMC1/16S
RG0474	R522	SMD resistor	470k 5% 0.063W	Kamaya	RMC1/16S
RG0334	R523	SMD resistor	330k 5% 0.063W	Kamaya	RMC1/16S
RG0334	R524	SMD resistor	330k 5% 0.063W	Kamaya	RMC1/16S

CODE	PART	DESCRIPT.	VALUE	MANUF.	TYPE
RG0274	R600	SMD resistor	270k 5% 0.063W	Kamaya	RMC1/16S
RG0334	R601	SMD resistor	330k 5% 0.063W	Kamaya	RMC1/16S
RG0102	R613	SMD resistor	1k0 5% 0.063W	Kamaya	RMC1/16S
RG0100	R614	SMD resistor	10 R 5% 0.063W	Kamaya	RMC1/16S
RG0103	R615	SMD resistor	10k 5% 0.063W	Kamaya	RMC1/16S
RG0102	R616	SMD resistor	1k0 5% 0.063W	Kamaya	RMC1/16S
RG0102	R617	SMD resistor	1k0 5% 0.063W	Kamaya	RMC1/16S
RG0102	R618	SMD resistor	1k0 5% 0.063W	Kamaya	RMC1/16S
RG0102	R619	SMD resistor	1k0 5% 0.063W	Kamaya	RMC1/16S
RG0102	R620	SMD resistor	1k0 5% 0.063W	Kamaya	RMC1/16S
RG0331	R621	SMD resistor	330R 5% 0.063W	Kamaya	RMC1/16S
RG0222	R623	SMD resistor	2k2 5% 0.063W	Kamaya	RMC1/16S
RG0221	R624	SMD resistor	220R 5% 0.063W	Kamaya	RMC1/16S
RG0331	R625	SMD resistor	330R 5% 0.063W	Kamaya	RMC1/16S
RG0331	R626	SMD resistor	330R 5% 0.063W	Kamaya	RMC1/16S
RG0331	R628	SMD resistor	330R 5% 0.063W	Kamaya	RMC1/16S
RG0222	R631	SMD resistor	2k2 5% 0.063W	Kamaya	RMC1/16S
RG0151	R640	SMD resistor	150R 5% 0.063W	Kamaya	RMC1/16S
RG0151	R641	SMD resistor	150R 5% 0.063W	Kamaya	RMC1/16S
RG0151	R642	SMD resistor	150R 5% 0.063W	Kamaya	RMC1/16S
RG0151	R643	SMD resistor	150R 5% 0.063W	Kamaya	RMC1/16S
RG0104	R650	SMD resistor	100k 5% 0.063W	Kamaya	RMC1/16S
AS2100	S603	*** EI KOODATTU VARAS- TOON ***			
AM0063	TP310	Microphone	Electret condenser-+65-+3dB	Primo	EM134K
VM0342	V100	SMD system connector	16 pin	AMP	338269-1
VM0016	V101	SMD B/B-connector	2x20 0.65mm pits	Hirose	DF15(0,8)-40DS-
VM0005	V102	Terminal srtp	5 pin	Samtec	ASP-61841-02-M
VW0107	V105	Power connector	male 4-pin	Elco	58-9155-004-000-
VI0707	V200	Sim card connector		Amphenol	C70710M0060152
LF0062	X100	SMD EMI filter	10nF/2A	Panasonic	ELKE103FA
LF0062	X101	SMD EMI filter	10nF/2A	Panasonic	ELKE103FA
X32766	X200	SMD crystal	32.768kHz +-30ppm	MicroCryst	MS1V-TK
AE0017	X600	Buzzer	13x11x3mm 1.5V/80mA	Primo	MB-11A-K
PA1810	Y200	*** EI KOODATTU VARAS- TOON ***			
AS0272	Y201	Sidekey set		Screenec	982568

Last  
update  
18.01.99

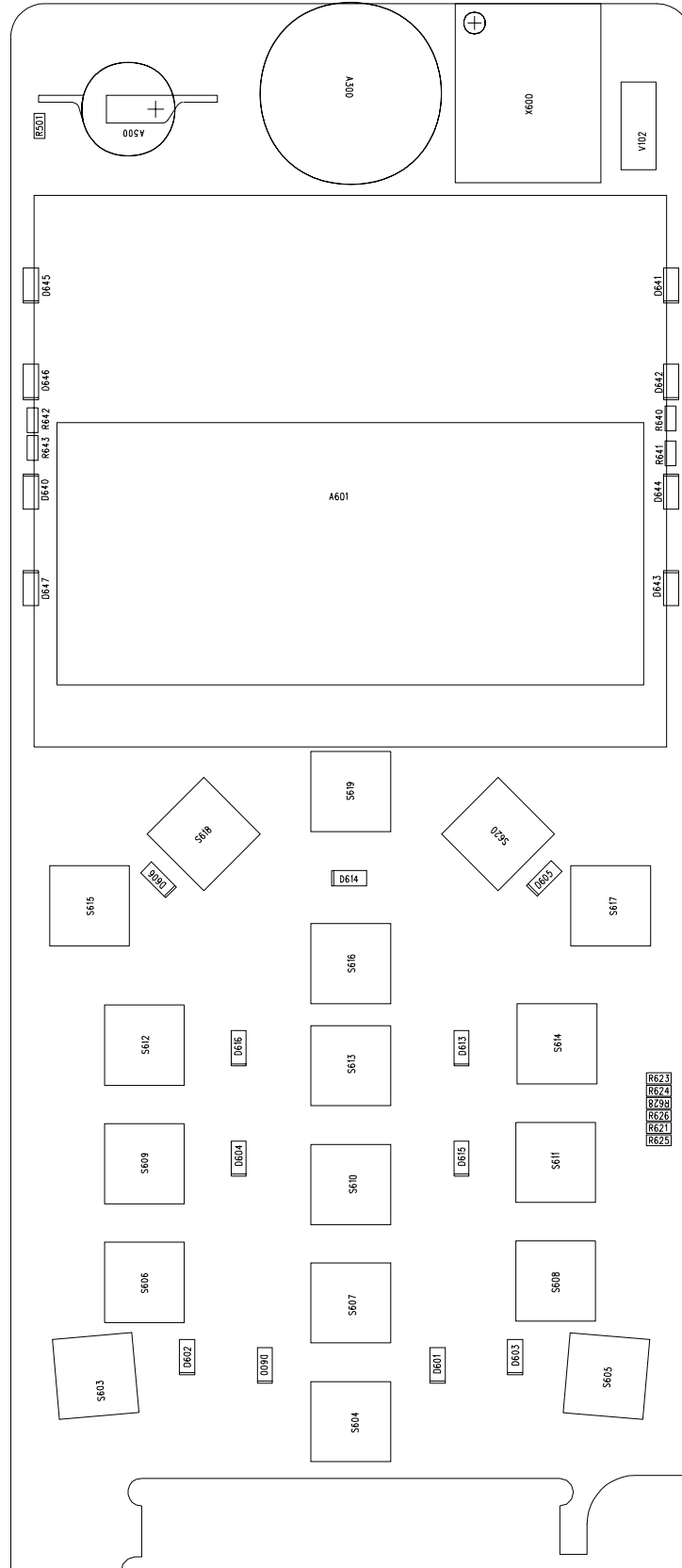

PA1810A1 850

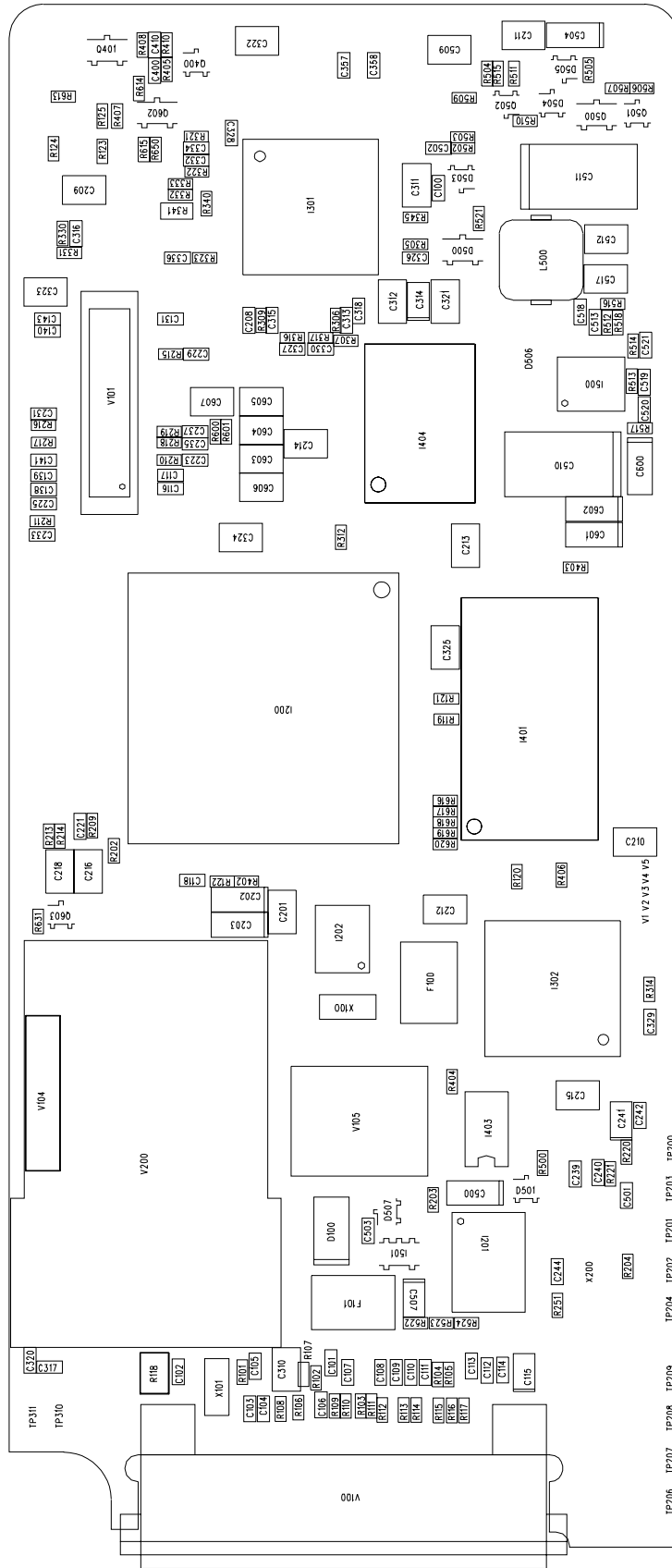

PA1810A1 820



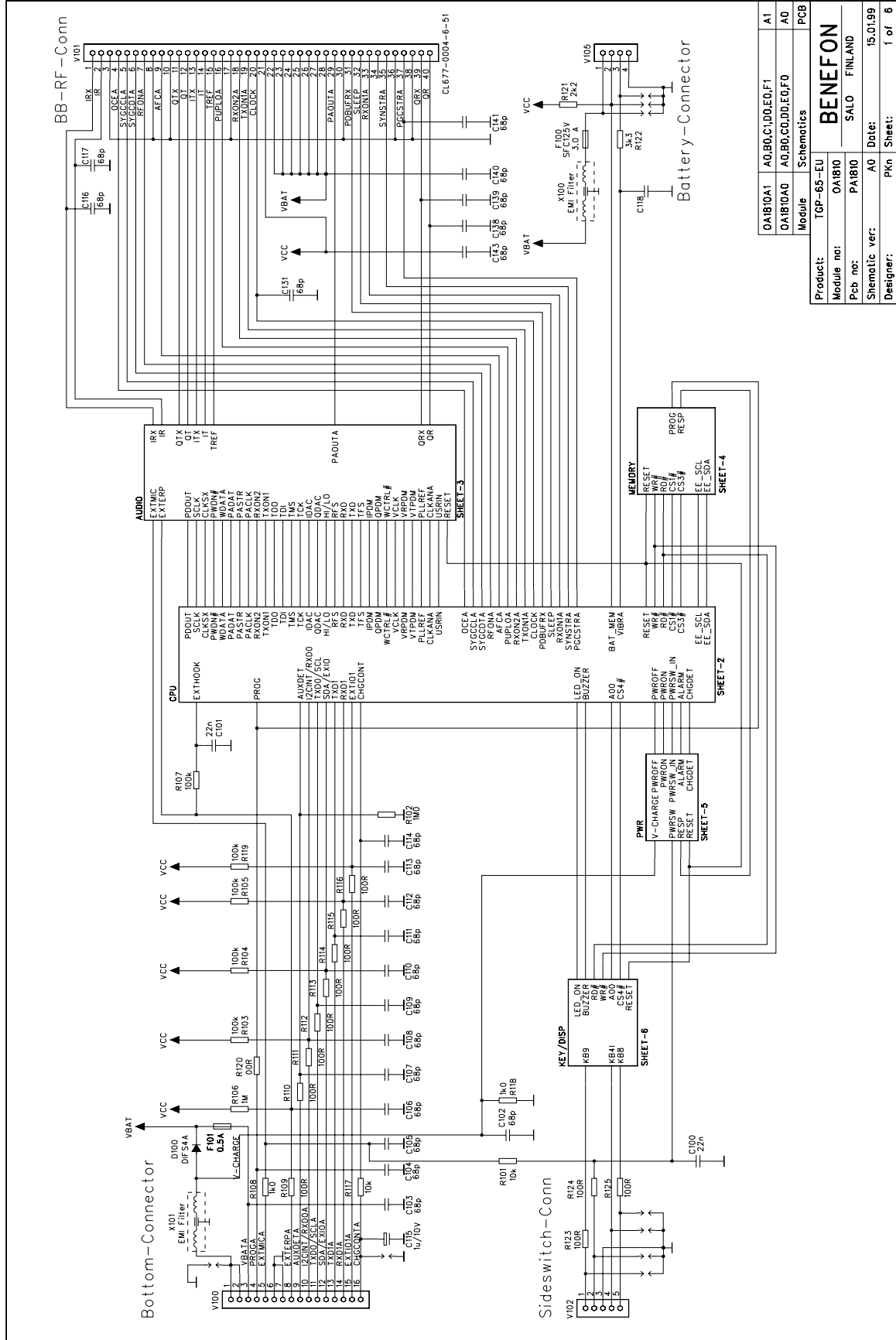

Module	OA1810A1	AQ,B0,C1,D0,E0,F1	A1
Module	OA1810A0	AQ,B0,C0,D0,E0,F0	A0
Module	Schematics		
Product:	TGP-65-EU		
Module no:	OA1810	BENEFON	
Pcb no:	PA1810	SALO FINLAND	
Schematic ver:	A0	Date:	15.01.99
Designer:	PKn	Sheet:	1 of 8



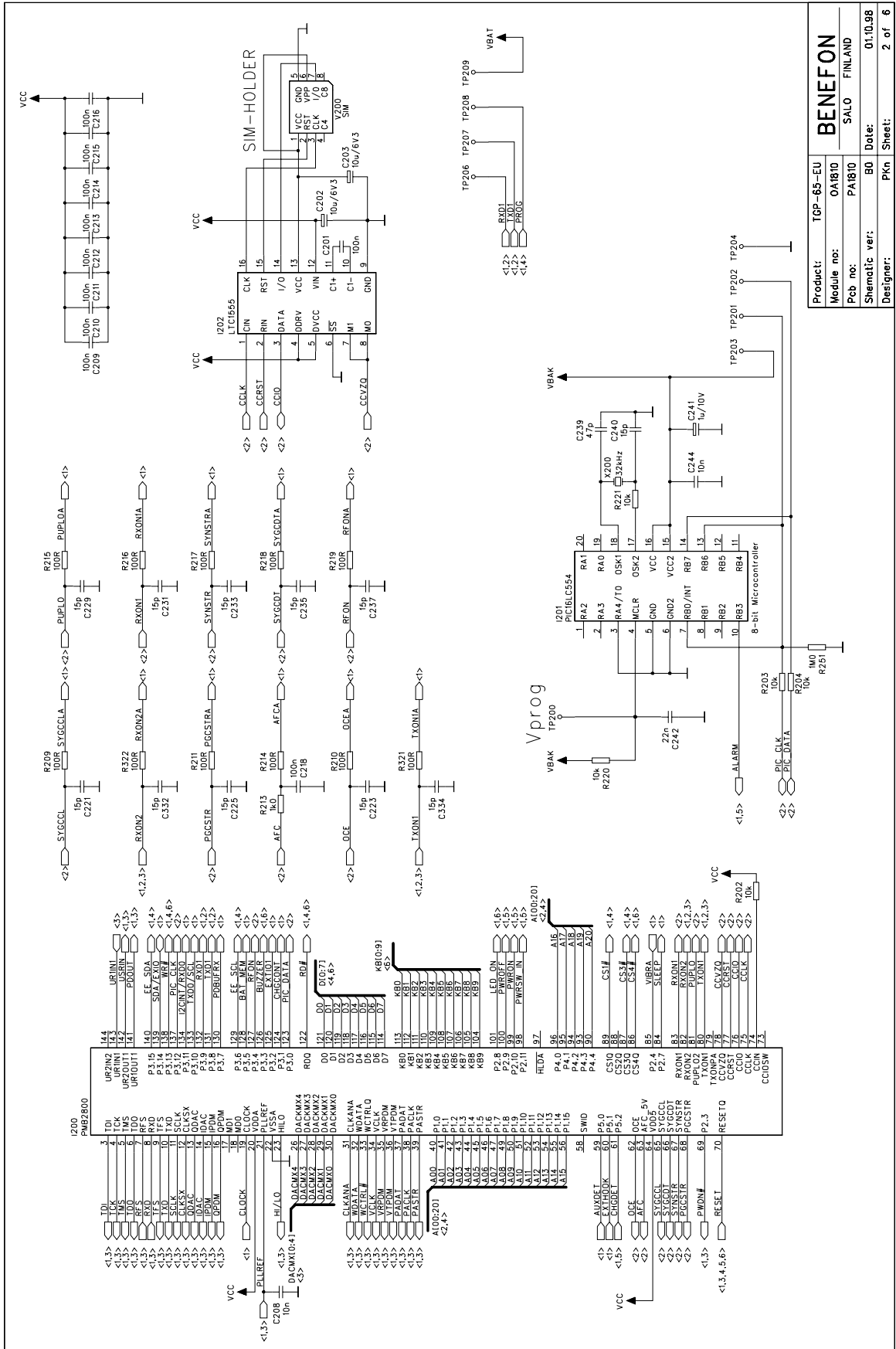



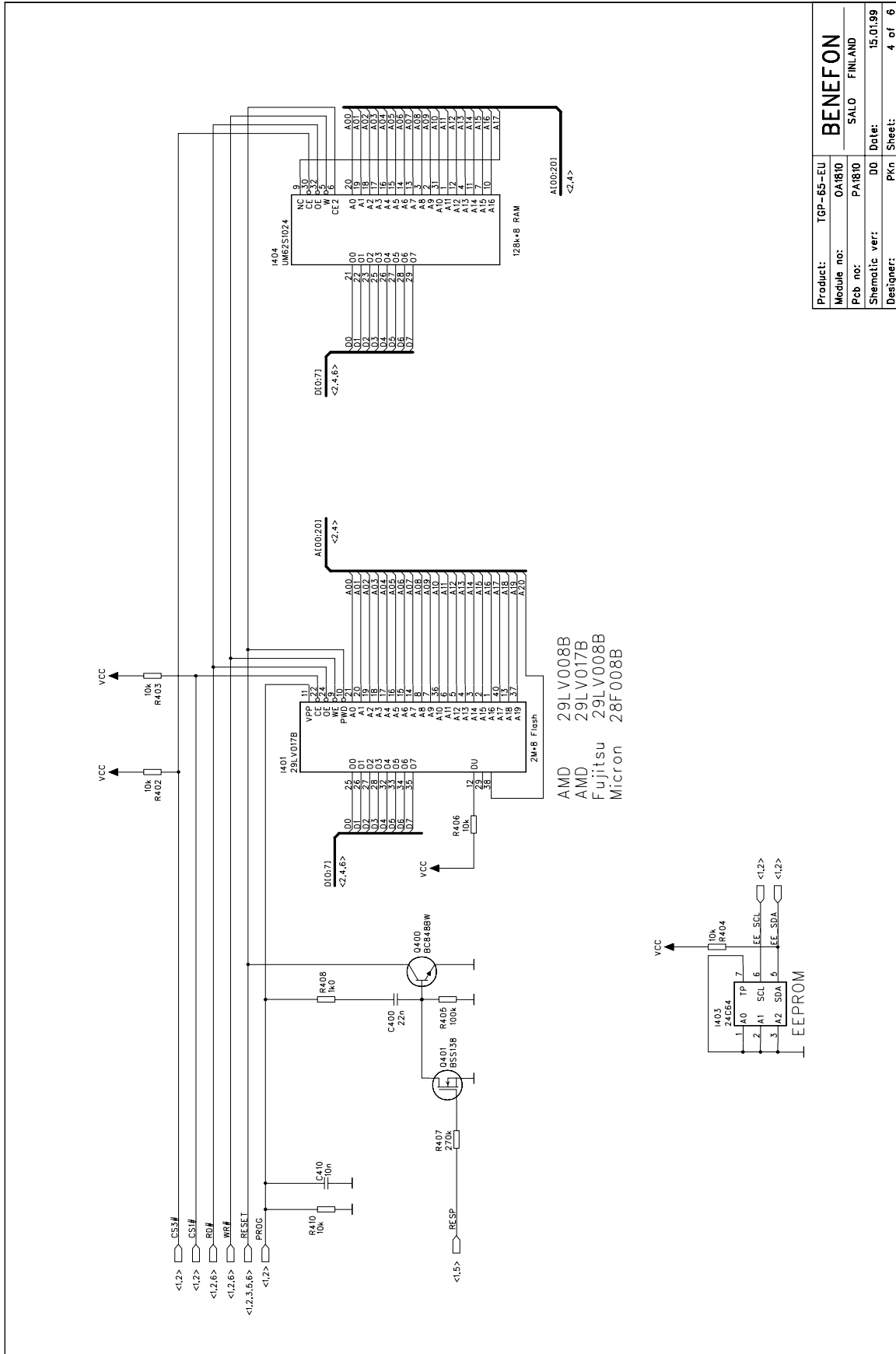

Product:	TGP-65-EU	<b>BENEFON</b>
Module no:	OA1810	SALO FINLAND
Pcb no:	PA1810	
Schematic ver:	00	Date: 15.01.99
Designer:	Pkn	Sheet: 4 of 6

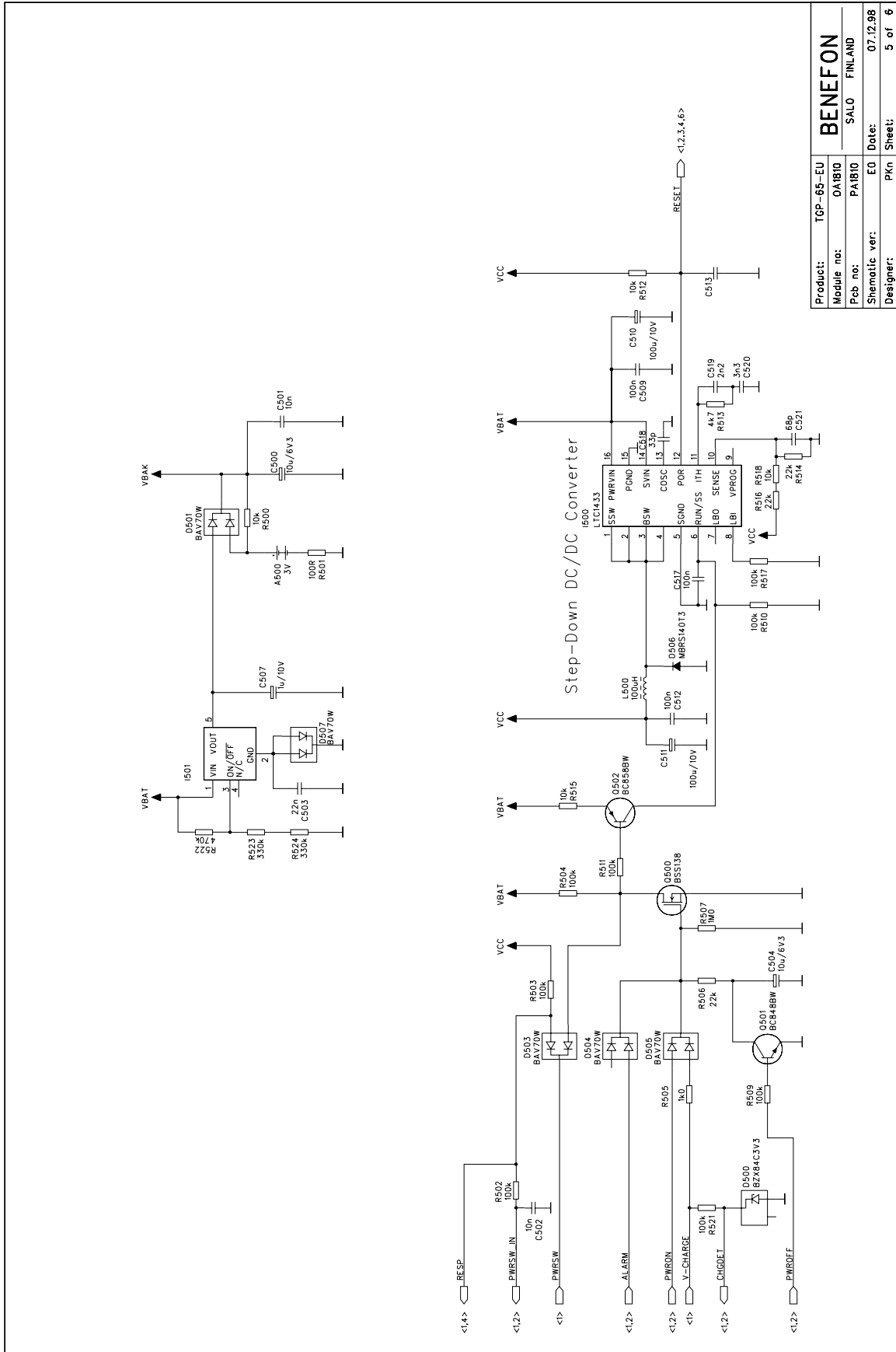

Product:	TGP-65-EU
Module no:	OA1810
Pcb no:	PAR1810
Schematic ver:	E0
Designer:	Pkn
Date:	07.12.98
Sheet:	5 of 6

**BENEFON**

SALO FINLAND

Date: 07.12.98

Sheet: 5 of 6

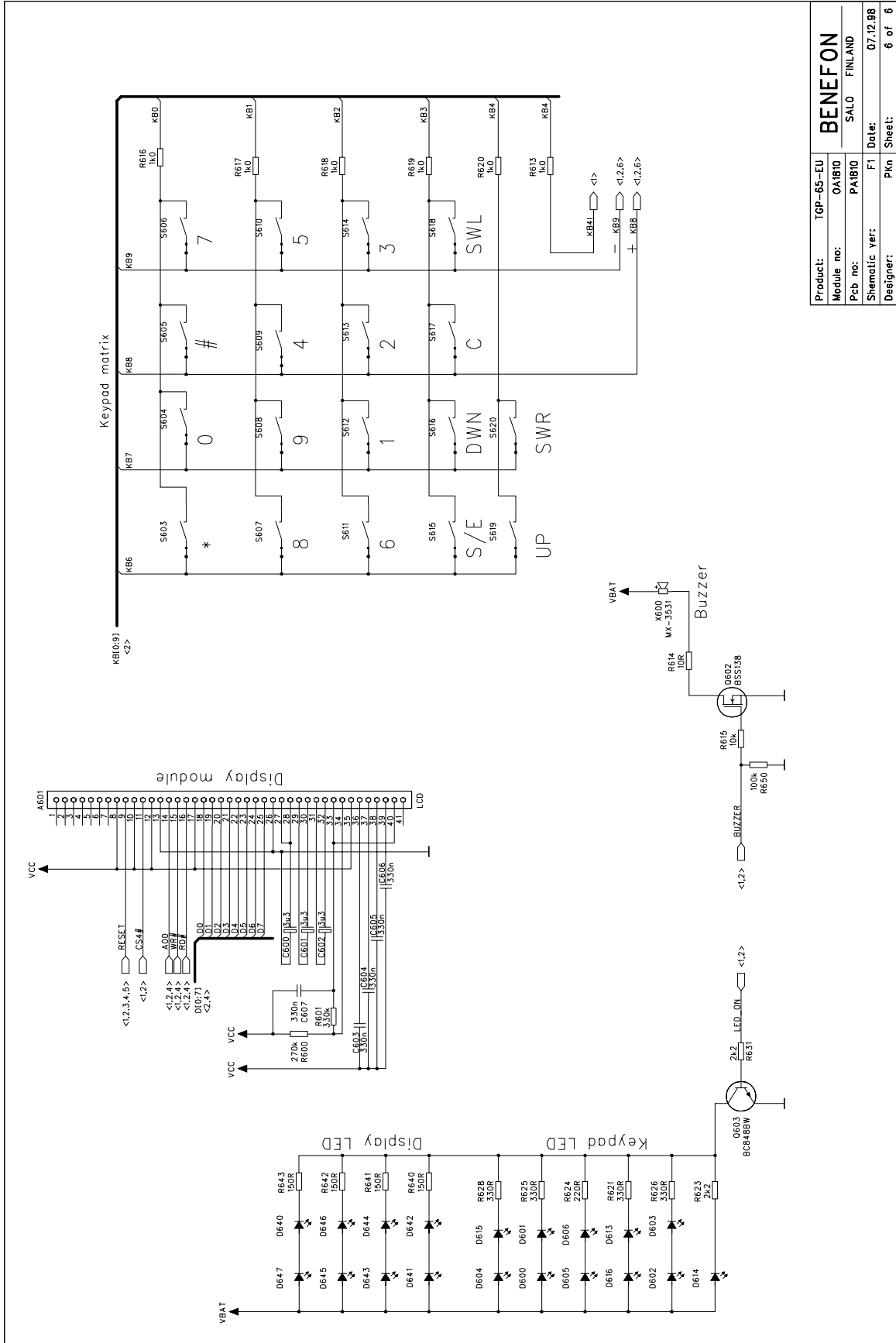

Product:	TGP-65-EU	<b>BENEFON</b>
Module no:	OA1810	SALO FINLAND
Pcb no:	PA1810	
Schematic ver:	F1	Date: 07.12.98
Designer:	Pkn	Sheet: 6 of 6

## 5.4 RF-module

OY1810-RF

### 5.4.1 General

The RF-Module is based on Siemens RF-chipset, which consists of GSM receiver circuit PMB 2411, modulator / TX circuit PMB2240 and synthesizer PMB2307. The final power amplifier is Hitachi PF01411A.

Radio module is powered by four 3.0 / 3.3 V linear regulators, which provide separate power supply for PLL synthesizer and VCO, modulator and TX-parts, other RF-parts as AGC-amplifier and LNA etc. and 13 MHz reference oscillator.

A block diagram of the RF-module

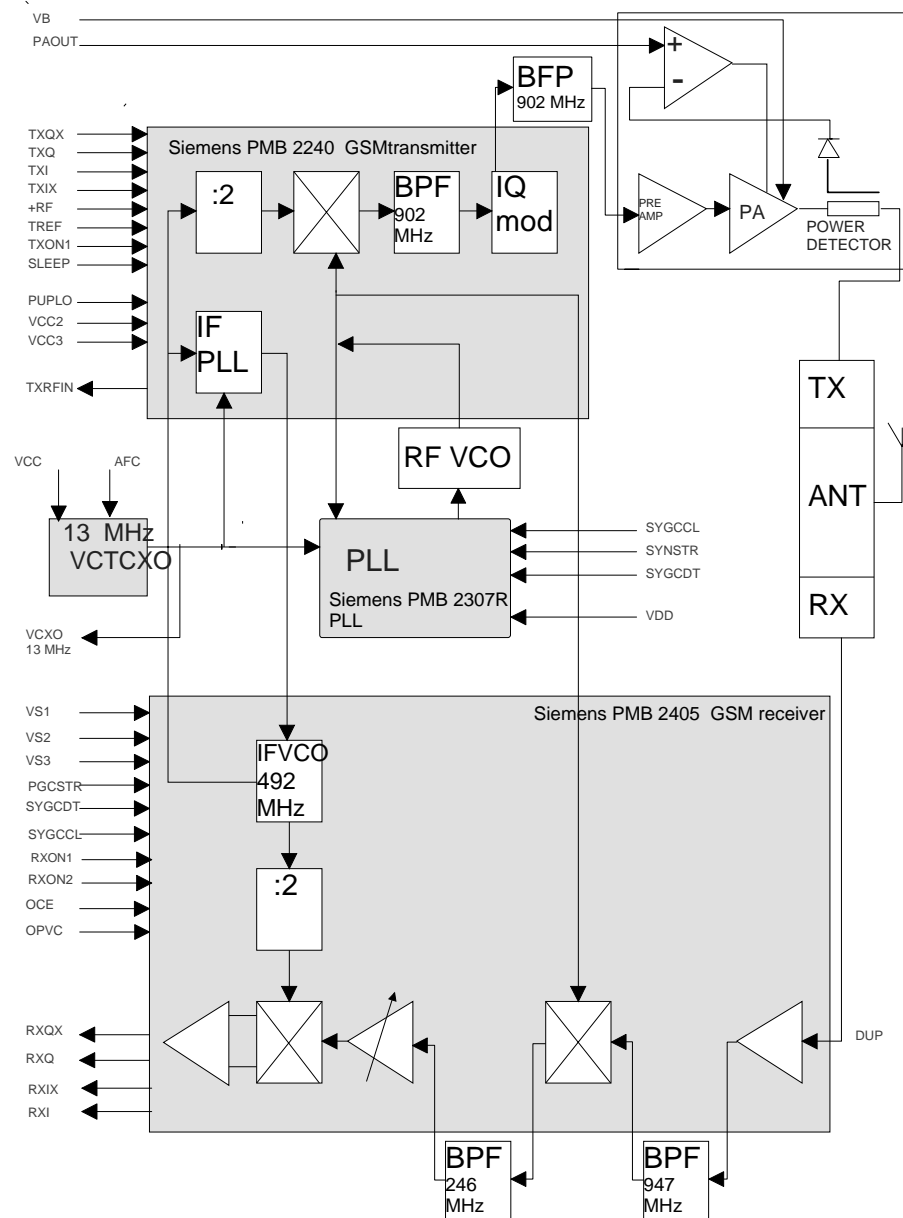

## 5.4.2 Receiver

The incoming RX signal from duplex-filter X546 is first amplified in LNA amplifier of PMB 2411, then filtered in X460 and then fed to the first mixer. In first mixer the received signal is down converted to the first IF which is 246 MHz and filtered in band-pass filter X480. After filtering the signal is amplified in three wire bus adjustable AGC (Automatic Gain Control) amplifier and fed internally into Quadrature demodulator where the signal is demodulated to baseband differential I/Q-signals. After demodulation the differential signals are filtered and amplified before the signals are fed into Baseband-board via connector V1.

## 5.4.3 Transmitter

The differential I/Q-signals from Baseband-board and the RF signal from synthesizer are fed to quadrature modulator I210 (PMB 2240). The modulated RF signal is then filtered (X501), amplified (Q520) and then fed into power amplifier I540 which output power is adjustable. The output power adjustment is done in comparator I6A, where the signals from baseband board and power output coupler/rectifier X545/D545 are compared. The modulated RF signal is then fed to the antenna via duplex-filter X546.

## 5.4.4 Synthesizer

The first local frequency (1181 MHz - 1206 MHz) is generated in VCO (voltage controlled oscillator) module X250 after that it is fed via balun network L260, L261 and C260 - C263 to the TX-chip I210 where it is sampled for prescaler and buffered and fed to RX-chip I410 (PMB 2411) to be used as a first local injection. The first local frequency is controlled by PLL-circuit I300 (PMB 2307) which is controlled by the u-processor of the baseband board via three wire serial control bus. The second local injection 246 MHz is generated in RX-chip by dividing by two the inbuild 492 MHz VCO signal. The second local frequency is controlled by fixed-frequency PLL-circuit which is build in to the TX-chip. TX-carrier frequency (890 MHz - 915 MHz) is generated by subtracting the 246 MHz 2nd local frequency from the first local frequency which is working from 1136 MHz to 1161 MHz in TX-mode. Both PLL:s are using the 13 MHz VCTCXO (Voltage Controlled Temperature Compensated X-tal Oscillator) signal as reference. The frequency of VCTCXO is controlled by u-processor of the baseband board thus taking care also of the AFC (Automatic Frequency Control) function.

## 5.4.5 Power supply and power switching.

The battery voltage is regulated in regulators I101, I102 and I103. The used supply voltages are +3.0 and +3.3 V. The power on/off switching is done from baseband board using output-enable pin each regulator.

## 5.4.6 Antenna and antenna connector

The antenna signal from / to duplex-filter is fed to the SMA-type antenna connector.



## 5.4.7 Parts list OY1810

OY1810

CODE	PART	DESCRIPT.	VALUE	MANUF.	TYPE
CG0330	C1	SMD capasitor NPO	33pF ñ5%	Murata	
CU3475	C101	SMD tantal	4.7uF/10V 20%	AVX	TAJA475M010R
CU3475	C102	SMD tantal	4.7uF/10V 20%	AVX	TAJA475M010R
CU3106	C103	SMD tantal	10uF / 6V +-20%	AVX	TAJA106M006R
CU3106	C104	SMD tantal	10uF / 6V +-20%	AVX	TAJA106M006R
CU3106	C105	SMD tantal	10uF / 6V +-20%	AVX	TAJA106M006R
CG0471	C106	SMD capasitor X7R	470pF ñ10%	Murata	
CG0471	C107	SMD capasitor X7R	470pF ñ10%	Murata	
CG0471	C108	SMD capasitor X7R	470pF ñ10%	Murata	
CG0680	C120	SMD capasitor NPO	68pF ñ5%	Murata	
CG0680	C121	SMD capasitor NPO	68pF ñ5%	Murata	
CG0680	C122	SMD capasitor NPO	68pF ñ5%	Murata	
CG0680	C123	SMD capasitor NPO	68pF ñ5%	Murata	
CG0680	C124	SMD capasitor NPO	68pF ñ5%	Murata	
CG0680	C130	SMD capasitor NPO	68pF ñ5%	Murata	
CG0680	C131	SMD capasitor NPO	68pF ñ5%	Murata	
CG0680	C132	SMD capasitor NPO	68pF ñ5%	Murata	
CG0680	C133	SMD capasitor NPO	68pF ñ5%	Murata	
CG0680	C134	SMD capasitor NPO	68pF ñ5%	Murata	
CG0680	C135	SMD capasitor NPO	68pF ñ5%	Murata	
CG0680	C136	SMD capasitor NPO	68pF ñ5%	Murata	
CG0680	C137	SMD capasitor NPO	68pF ñ5%	Murata	
CG0680	C138	SMD capasitor NPO	68pF ñ5%	Murata	
CG0102	C150	SMD capasitor X7R	1nF ñ10%	Murata	
CU3106	C151	SMD tantal	10uF / 6V +-20%	AVX	TAJA106M006R
CH0105	C152	SMD capasitor	1uF/-20/+80%/16V	TaiyoYuden	EMK212 F105Z00T
CG0103	C153	SMD capasitor X7R	10nF ñ10%	Murata	
CG0680	C160	SMD capasitor NPO	68pF ñ5%	Murata	
CD0104	C162	SMD capasitor	100 nF 10% 50 V X7R	Philips	
CG0330	C163	SMD capasitor NPO	33pF ñ5%	Murata	
CG0680	C170	SMD capasitor NPO	68pF ñ5%	Murata	
CG0102	C171	SMD capasitor X7R	1nF ñ10%	Murata	
CD0104	C172	SMD capasitor	100 nF 10% 50 V X7R	Philips	
CU3106	C181	SMD tantal	10uF / 6V +-20%	AVX	TAJA106M006R
CG0569	C2	SMD capasitor NPO	5.6pF ñ0,25pF	Murata	
CG0680	C201	SMD capasitor NPO	68pF ñ5%	Murata	
CG0680	C202	SMD capasitor NPO	68pF ñ5%	Murata	
CG0159	C205	SMD capasitor NPO	1.5pF ñ0,25pF	Murata	
CG0680	C210	SMD capasitor NPO	68pF ñ5%	Murata	
CG0223	C211	SMD capasitor X7R	22nF +80/-20%	Murata	
CG0680	C212	SMD capasitor NPO	68pF ñ5%	Murata	
CG0680	C213	SMD capasitor NPO	68pF ñ5%	Murata	
CG0680	C214	SMD capasitor NPO	68pF ñ5%	Murata	
CG0221	C220	SMD capasitor X7R	220pF ñ10%	Murata	
CG0392	C221	SMD capasitor X7R	3.9nF ñ10%	Murata	
CG0680	C225	SMD capasitor NPO	68pF ñ5%	Murata	
CG0221	C227	SMD capasitor X7R	220pF ñ10%	Murata	
CG0680	C228	SMD capasitor NPO	68pF ñ5%	Murata	
CG0103	C229	SMD capasitor X7R	10nF ñ10%	Murata	
CG0399	C235	SMD capasitor NPO	3.9pF ñ0,25pF	Murata	
CG0470	C240	SMD capasitor NPO	47pF ñ5%	Murata	
CG0470	C241	SMD capasitor NPO	47pF ñ5%	Murata	
CG0569	C242	SMD capasitor NPO	5.6pF ñ0,25pF	Murata	
CG0102	C245	SMD capasitor X7R	1nF ñ10%	Murata	
CG0680	C246	SMD capasitor NPO	68pF ñ5%	Murata	

CODE	PART	DESCRIPT.	VALUE	MANUF.	TYPE
CG0159	C248	SMD capasitor NPO	1.5pF $\bar{n}$ 0,25pF	Murata	
CG0102	C250	SMD capasitor X7R	1nF $\bar{n}$ 10%	Murata	
CH0105	C251	SMD capasitor	1uF/-20/+80%/16V	TaiyoYuden	EMK212 F105Z00T
CG0120	C260	SMD capasitor NPO	12pF $\bar{n}$ 5%	Murata	
CG0399	C261	SMD capasitor NPO	3.9pF $\bar{n}$ 0,25pF	Murata	
CG0120	C262	SMD capasitor NPO	12pF $\bar{n}$ 5%	Murata	
CG0399	C263	SMD capasitor NPO	3.9pF $\bar{n}$ 0,25pF	Murata	
CG0103	C270	SMD capasitor X7R	10nF $\bar{n}$ 10%	Murata	
CG0680	C271	SMD capasitor NPO	68pF $\bar{n}$ 5%	Murata	
CG0680	C272	SMD capasitor NPO	68pF $\bar{n}$ 5%	Murata	
CG0680	C275	SMD capasitor NPO	68pF $\bar{n}$ 5%	Murata	
CG0102	C276	SMD capasitor X7R	1nF $\bar{n}$ 10%	Murata	
CG0102	C280	SMD capasitor X7R	1nF $\bar{n}$ 10%	Murata	
CG0102	C281	SMD capasitor X7R	1nF $\bar{n}$ 10%	Murata	
CH0105	C285	SMD capasitor	1uF/-20/+80%/16V	TaiyoYuden	EMK212 F105Z00T
CG0680	C286	SMD capasitor NPO	68pF $\bar{n}$ 5%	Murata	
CH0105	C290	SMD capasitor	1uF/-20/+80%/16V	TaiyoYuden	EMK212 F105Z00T
CG0680	C291	SMD capasitor NPO	68pF $\bar{n}$ 5%	Murata	
000000	C3	*** EI KOODATTU VARAS- TOON ***			
CG0181	C300	SMD capasitor	180pF $\bar{n}$ 5% X7R	Murata	
CF0103	C301	SMD capasitor	10 nF 10% 50 V X7R	Philips	
CF0102	C302	SMD capasitor	1 nF 5 % NPO	Philips	
CG0181	C303	SMD capasitor	180pF $\bar{n}$ 5% X7R	Murata	
CG0103	C320	SMD capasitor X7R	10nF $\bar{n}$ 10%	Murata	
CG0680	C321	SMD capasitor NPO	68pF $\bar{n}$ 5%	Murata	
000000	C4	*** EI KOODATTU VARAS- TOON ***			
CG0121	C401	SMD capasitor X7R	120pF $\bar{n}$ 5%	Murata	
CG0829	C402	SMD capasitor NPO	8.2pF $\bar{n}$ 0,25pF	Murata	
CG0829	C403	SMD capasitor NPO	8.2pF $\bar{n}$ 0,25pF	Murata	
CG0829	C404	SMD capasitor NPO	8.2pF $\bar{n}$ 0,25pF	Murata	
CG0479	C405	SMD capasitor NPO	4.7pF $\bar{n}$ 0,25pF	Murata	
CG0479	C406	SMD capasitor NPO	4.7pF $\bar{n}$ 0,25pF	Murata	
CG0680	C407	SMD capasitor NPO	68pF $\bar{n}$ 5%	Murata	
CG0829	C408	SMD capasitor NPO	8.2pF $\bar{n}$ 0,25pF	Murata	
CG0220	C412	SMD capasitor NPO	22pF $\bar{n}$ 5%	Murata	
CG0220	C413	SMD capasitor NPO	22pF $\bar{n}$ 5%	Murata	
CG0220	C414	SMD capasitor NPO	22pF $\bar{n}$ 5%	Murata	
CG0220	C415	SMD capasitor NPO	22pF $\bar{n}$ 5%	Murata	
CF3473	C426	*** EI KOODATTU VARAS- TOON ***			
CF3473	C427	*** EI KOODATTU VARAS- TOON ***			
CG0103	C435	SMD capasitor X7R	10nF $\bar{n}$ 10%	Murata	
CG0680	C436	SMD capasitor NPO	68pF $\bar{n}$ 5%	Murata	
CG0330	C440	SMD capasitor NPO	33pF $\bar{n}$ 5%	Murata	
CG0103	C445	SMD capasitor X7R	10nF $\bar{n}$ 10%	Murata	
CG0680	C450	SMD capasitor NPO	68pF $\bar{n}$ 5%	Murata	
CG0121	C451	SMD capasitor X7R	120pF $\bar{n}$ 5%	Murata	
CG0102	C452	SMD capasitor X7R	1nF $\bar{n}$ 10%	Murata	
CG0339	C453	SMD capasitor NPO	3.3pF $\bar{n}$ 0,25pF	Murata	
CG0680	C455	SMD capasitor NPO	68pF $\bar{n}$ 5%	Murata	
CG0680	C456	SMD capasitor NPO	68pF $\bar{n}$ 5%	Murata	
CG0121	C457	SMD capasitor X7R	120pF $\bar{n}$ 5%	Murata	
CG0229	C458	SMD capasitor NPO	2.2pF $\bar{n}$ 0,25pF	Murata	
000000	C459	*** EI KOODATTU VARAS- TOON ***			
CG0103	C465	SMD capasitor X7R	10nF $\bar{n}$ 10%	Murata	
CG0680	C466	SMD capasitor NPO	68pF $\bar{n}$ 5%	Murata	
CG0680	C467	SMD capasitor NPO	68pF $\bar{n}$ 5%	Murata	

CODE	PART	DESCRIPT.	VALUE	MANUF.	TYPE
CG0109	C471	SMD capasitor NPO	1.0pF $\bar{n}$ 0,25pF	Murata	
CG0399	C472	SMD capasitor NPO	3.9pF $\bar{n}$ 0,25pF	Murata	
CG0399	C473	SMD capasitor NPO	3.9pF $\bar{n}$ 0,25pF	Murata	
CG0102	C480	SMD capasitor X7R	1nF $\bar{n}$ 10%	Murata	
CG0102	C481	SMD capasitor X7R	1nF $\bar{n}$ 10%	Murata	
000000	C482	*** EI KOODATTU VARAS-TOON ***			
CG0330	C485	SMD capasitor NPO	33pF $\bar{n}$ 5%	Murata	
CG0330	C486	SMD capasitor NPO	33pF $\bar{n}$ 5%	Murata	
000000	C487	*** EI KOODATTU VARAS-TOON ***			
CG0102	C488	SMD capasitor X7R	1nF $\bar{n}$ 10%	Murata	
CG0680	C501	SMD capasitor NPO	68pF $\bar{n}$ 5%	Murata	
CG0181	C510	SMD capasitor	180pF $\bar{n}$ 5% X7R	Murata	
CG0181	C511	SMD capasitor	180pF $\bar{n}$ 5% X7R	Murata	
CG0829	C520	SMD capasitor NPO	8.2pF $\bar{n}$ 0,25pF	Murata	
CG0102	C522	SMD capasitor X7R	1nF $\bar{n}$ 10%	Murata	
CG0680	C523	SMD capasitor NPO	68pF $\bar{n}$ 5%	Murata	
000000	C524	*** EI KOODATTU VARAS-TOON ***			
CG0331	C535	SMD capasitor X7R	330pF $\bar{n}$ 10%	Murata	
CH0105	C536	SMD capasitor	1uF/-20/+80%/16V	TaiyoYuden	EMK212 F105Z00T
CG0680	C537	SMD capasitor NPO	68pF $\bar{n}$ 5%	Murata	
CU1107	C538	SMD tantal	100uF/10V +20%	AVX	TAJD107M010R
CU1107	C540	SMD tantal	100uF/10V +20%	AVX	TAJD107M010R
CG0680	C541	SMD capasitor NPO	68pF $\bar{n}$ 5%	Murata	
CG0680	C542	SMD capasitor NPO	68pF $\bar{n}$ 5%	Murata	
CG0680	C545	SMD capasitor NPO	68pF $\bar{n}$ 5%	Murata	
CG0680	C546	SMD capasitor NPO	68pF $\bar{n}$ 5%	Murata	
CG0680	C547	SMD capasitor NPO	68pF $\bar{n}$ 5%	Murata	
CG0150	C548	SMD capasitor NPO	15pF $\bar{n}$ 5%	Murata	
DC0229	D401	SMD silicon tuning diode	1V/19pF...4V/11pF	Toshiba	1SV229
DC0229	D402	SMD silicon tuning diode	1V/19pF...4V/11pF	Toshiba	1SV229
DY0062	D545	SMD shcottky diode	40V 20mA	Siemens	BAT 62
000000	I1	*** EI KOODATTU VARAS-TOON ***			
IR5206	I101	Voltage regulator	3.0V/1%/50mA	Micrel	LP2982IM5-3.0
IR5205	I102	Voltage regulator	3.3V/1%/50mA	Micrel	LP2982IM5-3.3
IR5205	I103	Voltage regulator	3.3V/1%/50mA	Micrel	LP2982IM5-3.3
IW1411	I2	RF-power amplifier	GSM	Hitashi	PF01411A
IF2240	I210	GSM transmitter		Siemens	PMB2240 v.1.6
IA2022	I3	2xop.amp	Low power high-speed	Texas	TLE 2022 ID
IS2307	I300	PLL freg.synthesizer	TSSOP-16	DE	PMB2307R v.1.1
IF2411	I410	GSM-receiver		Siemens	PMB 2411 V1.1
LC3223	L210	SMD inductor	22n +-2%	Panasonic	ELJRE22NGF2
LC3183	L211	SMD inductor	18n +-2%	PANA-SONIC	ELJRE18NGF2
LC3223	L235	SMD inductor	22n +-2%	Panasonic	ELJRE22NGF2
LC3472	L240	SMD inductor	4n7 +-2%	Panasonic	ELJRE4N7ZF2
LC3472	L245	SMD inductor	4n7 +-2%	Panasonic	ELJRE4N7ZF2
LC3472	L246	SMD inductor	4n7 +-2%	Panasonic	ELJRE4N7ZF2
LC3123	L260	SMD inductor	12n +-2%	PANA-SONIC	ELJRE12NGF2
LC3123	L261	SMD inductor	12n +-2%	PANA-SONIC	ELJRE12NGF2
LC1183	L401	SMD inductor	18nH +-20%	Coilcraft	0805CS-180XMBC
LC3682	L402	SMD inductor	6n8 +-2%	Panasonic	ELJRE6N8ZF2
LC3562	L455	SMD inductor	5n6 +-2%	Panasonic	ELJRE5N6ZF2
LC3123	L456	SMD inductor	12n +-2%	PANA-SONIC	ELJRE12NGF2
LC3273	L460	SMD inductor	27nH +-2%	Panasonic	ELJRE27NGF2

CODE	PART	DESCRIPT.	VALUE	MANUF.	TYPE
LC3183	L461	SMD inductor	18n +-2%	PANA-SONIC	ELJRE18NGF2
LC3563	L480	SMD inductor	56nH +-2%	Panasonic	ELJRE56NGF3
LC3563	L481	SMD inductor	56nH +-2%	Panasonic	ELJRE56NGF3
LC3473	L485	SMD inductor	47n +-2%	Panasonic	ELJRE47NGF2
LC3473	L486	SMD inductor	47n +-2%	Panasonic	ELJRE47NGF2
LC3272	L520	SMD inductor	2n7 +-2%	Panasonic	ELJRE2N7ZF2
LC3183	L522	SMD inductor	18n +-2%	PANA-SONIC	ELJRE18NGF2
LC3272	L523	SMD inductor	2n7 +-2%	Panasonic	ELJRE2N7ZF2
QS0060	Q1	SMD transistor arrey	NPN/PNP 100mA/50V	Siemens	BCR 10PN
QS0060	Q2	SMD transistor arrey	NPN/PNP 100mA/50V	Siemens	BCR 10PN
QS0848	Q3	SMD transistor	NPN 0.1A/30V hFE 110-800	Philips	BC848BW, 115
QS0848	Q4	SMD transistor	NPN 0.1A/30V hFE 110-800	Philips	BC848BW, 115
QA4867	Q520	SMD RF-transistor	NPN G=13dB NF=1.2dB/1GHz	Sanyo	2SC4867-4
RC0000	R1	SMD resistor	0 R	Kamaya	
RG0820	R122	SMD resistor	82R 5% 0.063W	Kamaya	RMC1/16S
RG0333	R150	SMD resistor	33k 5% 0.063W	Kamaya	RMC1/16S
RG0333	R151	SMD resistor	33k 5% 0.063W	Kamaya	RMC1/16S
RG0121	R152	SMD resistor	120R 5% 0.063W	Kamaya	RMC1/16S
RG0104	R160	SMD resistor	100k 5% 0.063W	Kamaya	RMC1/16S
RG0102	R161	SMD resistor	1k0 5% 0.063W	Kamaya	RMC1/16S
RG0102	R170	SMD resistor	1k0 5% 0.063W	Kamaya	RMC1/16S
RG0104	R171	SMD resistor	100k 5% 0.063W	Kamaya	RMC1/16S
RG0220	R181	SMD resistor	22R 5% 0.063W	Kamaya	RMC1/16S
RG0100	R2	SMD resistor	10 R 5% 0.063W	Kamaya	RMC1/16S
RG0272	R201	SMD resistor	2k7 5% 0.063W	Kamaya	RMC1/16S
RG0272	R202	SMD resistor	2k7 5% 0.063W	Kamaya	RMC1/16S
RG0272	R203	SMD resistor	2k7 5% 0.063W	Kamaya	RMC1/16S
RG0272	R204	SMD resistor	2k7 5% 0.063W	Kamaya	RMC1/16S
RG0562	R205	SMD resistor	5k6 5% 0.063W	Kamaya	RMC1/16S
RG0562	R206	SMD resistor	5k6 5% 0.063W	Kamaya	RMC1/16S
RG0100	R210	SMD resistor	10 R 5% 0.063W	Kamaya	RMC1/16S
RG0100	R211	SMD resistor	10 R 5% 0.063W	Kamaya	RMC1/16S
RG0331	R212	SMD resistor	330R 5% 0.063W	Kamaya	RMC1/16S
RG0103	R213	SMD resistor	10k 5% 0.063W	Kamaya	RMC1/16S
RG0103	R220	SMD resistor	10k 5% 0.063W	Kamaya	RMC1/16S
RG0822	R221	SMD resistor	8k2 5% 0.063W	Kamaya	RMC1/16S
RG0472	R225	SMD resistor	4k7 5% 0.063W	Kamaya	RMC1/16S
RG0100	R245	SMD resistor	10 R 5% 0.063W	Kamaya	RMC1/16S
RG0820	R250	SMD resistor	82R 5% 0.063W	Kamaya	RMC1/16S
RG0220	R255	SMD resistor	22R 5% 0.063W	Kamaya	RMC1/16S
RG0221	R256	SMD resistor	220R 5% 0.063W	Kamaya	RMC1/16S
RG0221	R257	SMD resistor	220R 5% 0.063W	Kamaya	RMC1/16S
RG0330	R270	SMD resistor	33R 5% 0.063W	Kamaya	RMC1/16S
RG0820	R275	SMD resistor	82R 5% 0.063W	Kamaya	RMC1/16S
RG0561	R280	SMD resistor	560R 5% 0.063W	Kamaya	RMC1/16S
RG0820	R285	SMD resistor	82R 5% 0.063W	Kamaya	RMC1/16S
RG0820	R291	SMD resistor	82R 5% 0.063W	Kamaya	RMC1/16S
RG0332	R3	SMD resistor	3k3 5% 0.063W	Kamaya	RMC1/16S
RG1512	R300	SMD resistor	5k1 1% 0.063W	KOA	???????
RG0332	R301	SMD resistor	3k3 5% 0.063W	Kamaya	RMC1/16S
RG0103	R303	SMD resistor	10k 5% 0.063W	Kamaya	RMC1/16S
RG0102	R310	SMD resistor	1k0 5% 0.063W	Kamaya	RMC1/16S
RG0102	R311	SMD resistor	1k0 5% 0.063W	Kamaya	RMC1/16S
RG0472	R312	SMD resistor	4k7 5% 0.063W	Kamaya	RMC1/16S
RG0100	R320	SMD resistor	10 R 5% 0.063W	Kamaya	RMC1/16S
RG0102	R4	SMD resistor	1k0 5% 0.063W	Kamaya	RMC1/16S
RG0472	R401	SMD resistor	4k7 5% 0.063W	Kamaya	RMC1/16S
RG0472	R402	SMD resistor	4k7 5% 0.063W	Kamaya	RMC1/16S

CODE	PART	DESCRIPT.	VALUE	MANUF.	TYPE
RG0472	R403	SMD resistor	4k7 5% 0.063W	Kamaya	RMC1/16S
RG0561	R404	SMD resistor	560R 5% 0.063W	Kamaya	RMC1/16S
RG0561	R405	SMD resistor	560R 5% 0.063W	Kamaya	RMC1/16S
RG0100	R435	SMD resistor	10 R 5% 0.063W	Kamaya	RMC1/16S
RG0339	R450	SMD resistor	3R3 5% 0.063W	KOA	
RG0339	R451	SMD resistor	3R3 5% 0.063W	KOA	
RG0331	R460	SMD resistor	330R 5% 0.063W	Kamaya	RMC1/16S
RG0390	R461	SMD resistor	39R 5% 0.063W	Kamaya	RMC1/16S
RG0100	R465	SMD resistor	10 R 5% 0.063W	Kamaya	RMC1/16S
RG0102	R475	SMD resistor	1k0 5% 0.063W	Kamaya	RMC1/16S
RG0102	R476	SMD resistor	1k0 5% 0.063W	Kamaya	RMC1/16S
RG0102	R477	SMD resistor	1k0 5% 0.063W	Kamaya	RMC1/16S
RG0100	R485	SMD resistor	10 R 5% 0.063W	Kamaya	RMC1/16S
RG0102	R5	SMD resistor	1k0 5% 0.063W	Kamaya	RMC1/16S
RG0271	R501	SMD resistor	270R 5% 0.063W	Kamaya	RMC1/16S
RG0180	R502	SMD resistor	18R 5% 0.063W	Kamaya	RMC1/16S
RG0271	R503	SMD resistor	270R 5% 0.063W	Kamaya	RMC1/16S
RG0820	R508	SMD resistor	82R 5% 0.063W	Kamaya	RMC1/16S
RG0472	R510	SMD resistor	4k7 5% 0.063W	Kamaya	RMC1/16S
RG0103	R511	SMD resistor	10k 5% 0.063W	Kamaya	RMC1/16S
RG0822	R521	SMD resistor	8k2 5% 0.063W	Kamaya	RMC1/16S
RG0121	R522	SMD resistor	120R 5% 0.063W	Kamaya	RMC1/16S
RG0104	R523	SMD resistor	100k 5% 0.063W	Kamaya	RMC1/16S
RG0242	R535	SMD resistor	2k4 5% 0.063W	Kamaya	RMC1/16S
RG0101	R536	SMD resistor	100R 5% 0.063W	Kamaya	RMC1/16S
RG0471	R540	SMD resistor	470R 5% 0.063W	Kamaya	RMC1/16S
RG0120	R541	SMD resistor	12R 5% 0.063W	Kamaya	RMC1/16S
RG0471	R542	SMD resistor	470R 5% 0.063W	Kamaya	RMC1/16S
RG0103	R545	SMD resistor	10k 5% 0.063W	Kamaya	RMC1/16S
RG0472	R546	SMD resistor	4k7 5% 0.063W	Kamaya	RMC1/16S
RG0103	R547	SMD resistor	10k 5% 0.063W	Kamaya	RMC1/16S
RG0101	R548	SMD resistor	100R 5% 0.063W	Kamaya	RMC1/16S
RG0102	R6	SMD resistor	1k0 5% 0.063W	Kamaya	RMC1/16S
RG0102	R7	SMD resistor	1k0 5% 0.063W	Kamaya	RMC1/16S
VN0016	V100	SMD B/B-connector	2x20 0.65mm pits	Hirose	DF15(6,2)-40DP-
XO1171	X1	VCO 2.6V	1136--1206MHz	Murata	MQE904-1171
LF0062	X110	SMD EMI filter	10nF/2A	Panasonic	ELKE103FA
XO4130	X150	VCTCXO	13.0 MHz	Teletec	TCO-801HL
XW1947	X3	*** EI KOODATTU VARAS- TOON ***			
XW1246	X480	*** EI KOODATTU VARAS- TOON ***			
XW0902	X501	SAW filter NMT/GSM	902,5MHz	Fujitsu	FAR-F5CC-902M50-
XI0005	X545	Directional coupler	NMT450	MKT Taisei	DCS3120-09
OD0241	X546	Duplex filter GSM		Murata	DFYG902CR947NHA
000000	Y3	*** EI KOODATTU VARAS- TOON ***			
000000	Y4	*** EI KOODATTU VARAS- TOON ***			
PY1810	Y56	PCB for OY1810			
000000	Y65	*** EI KOODATTU VARAS- TOON ***			
000000	Y66	*** EI KOODATTU VARAS- TOON ***			
000000	Y67	*** EI KOODATTU VARAS- TOON ***			
000000	Y68	*** EI KOODATTU VARAS- TOON ***			
000000	Y69	*** EI KOODATTU VARAS- TOON ***			

CODE	PART	DESCRIPT.	VALUE	MANUF.	TYPE
000000	Y70	*** EI KOODATTU VARAS- TOON ***			

Last  
update  
15.09.98















# 5.5 MECHANICS

